



Valmet – unique offering with process technology, automation and services

Roadshow presentation  
September 2022

# Agenda

## Valmet roadshow presentation

1 Valmet in brief

2 Investment highlights

3 Financials

4 Summary



# Valmet in brief

# We have strong market shares and unique offering

## Process technologies



Board and Paper

Market position  
**#1**



Pulp and Energy

Market position  
**#1-3**

## Services



Market position  
**#1-2**

## Automation



Flow Control

Market position in Pulp and Paper  
**#1**

### Strong positions in

- Control valves and demanding on/off valves
- Process industry segments including pulp and paper



Automation Systems

Market position in Pulp and Paper  
**#1-3**

Niche positions in other process industry segments

# Valmet's development since 2013

Orders received  
(EUR billion)

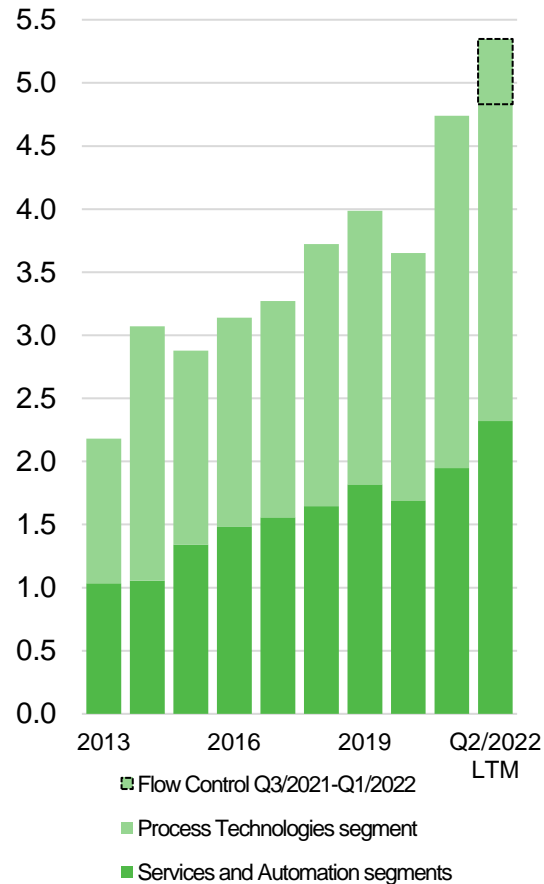

Net sales  
(EUR billion)

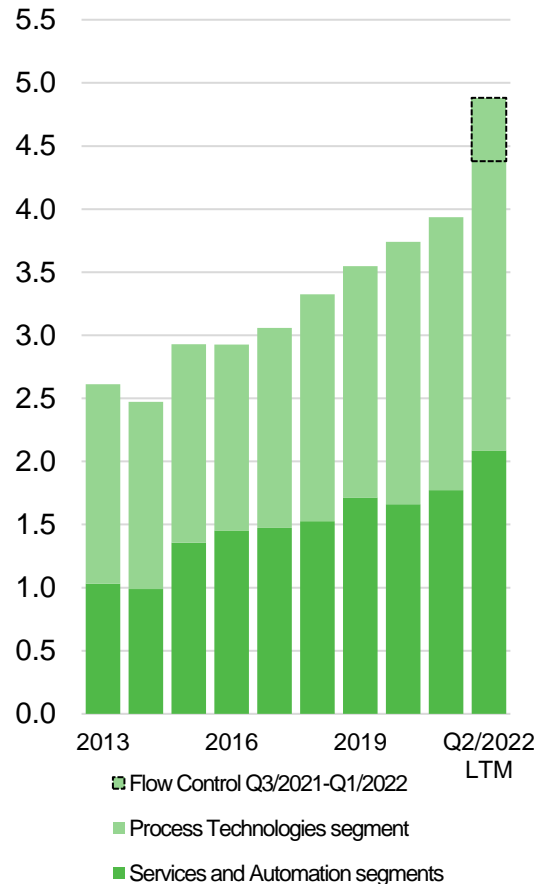

Comparable EBITA  
(EUR million)

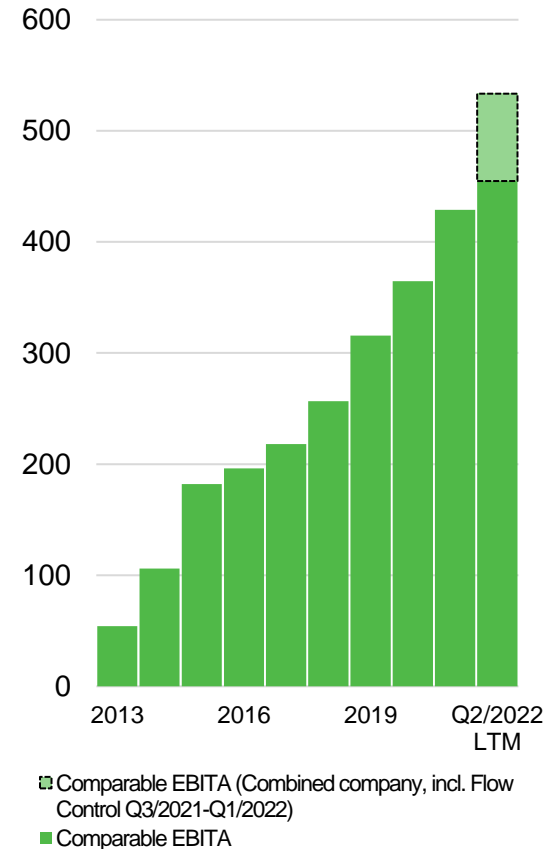

Comparable EBITA margin  
(%)

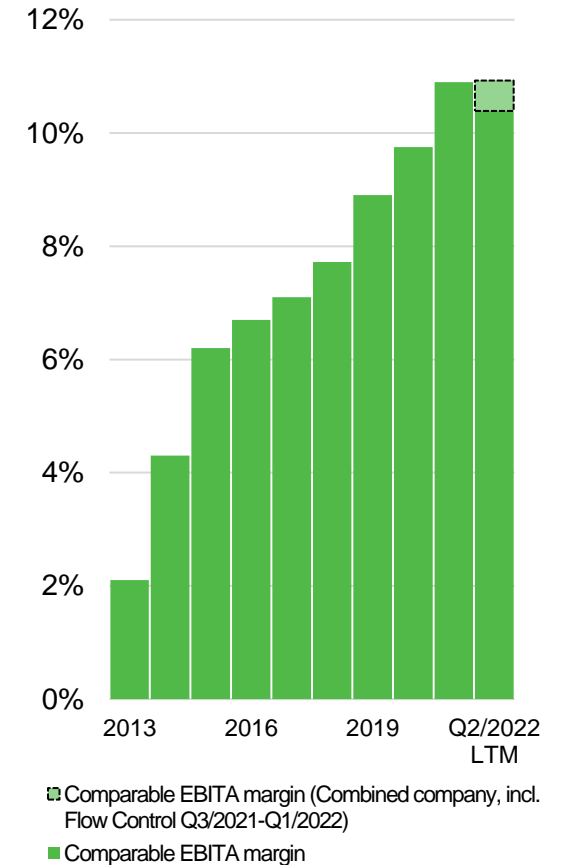

Figures for Flow Control Q3/2021–Q1/2022 and combined company are illustrative. Source for Flow Control Q3/2021–Q1/2022 figures: Neles' financial statements 2021 and interim report Q1/2022. 2013 figures on carve-out basis. 2013–2020 figures have not been restated.

# Valmet has three strong segments

Illustrative key figures for LTM Q2/2022

**Orders received**  
EUR 5,347 million

**Net sales**  
EUR 4,882 million

**Comparable EBITA**  
EUR 534 million

**Comparable EBITA margin**  
10.9%

**Order backlog**  
EUR 4,784 million

**Employees**  
17,670

Net sales by segment

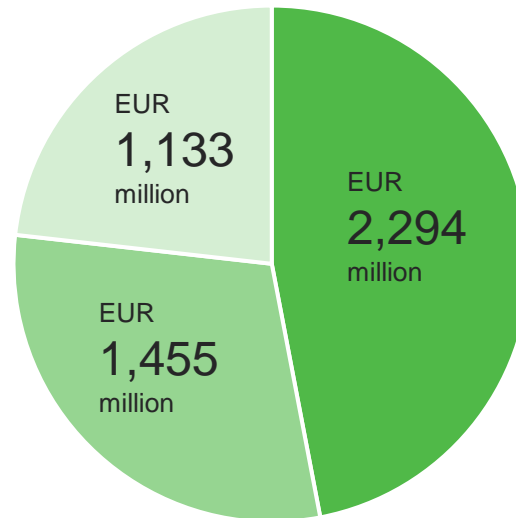

- Process Technologies
- Services
- Automation

Comparable EBITA by segment

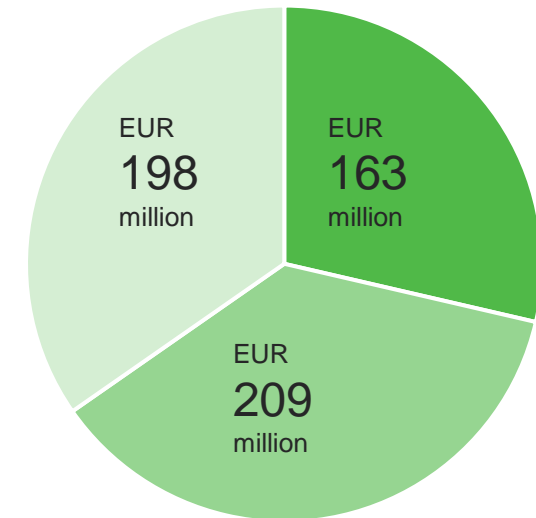





- Process Technologies
- Services
- Automation

Illustrative figures of the combined company.

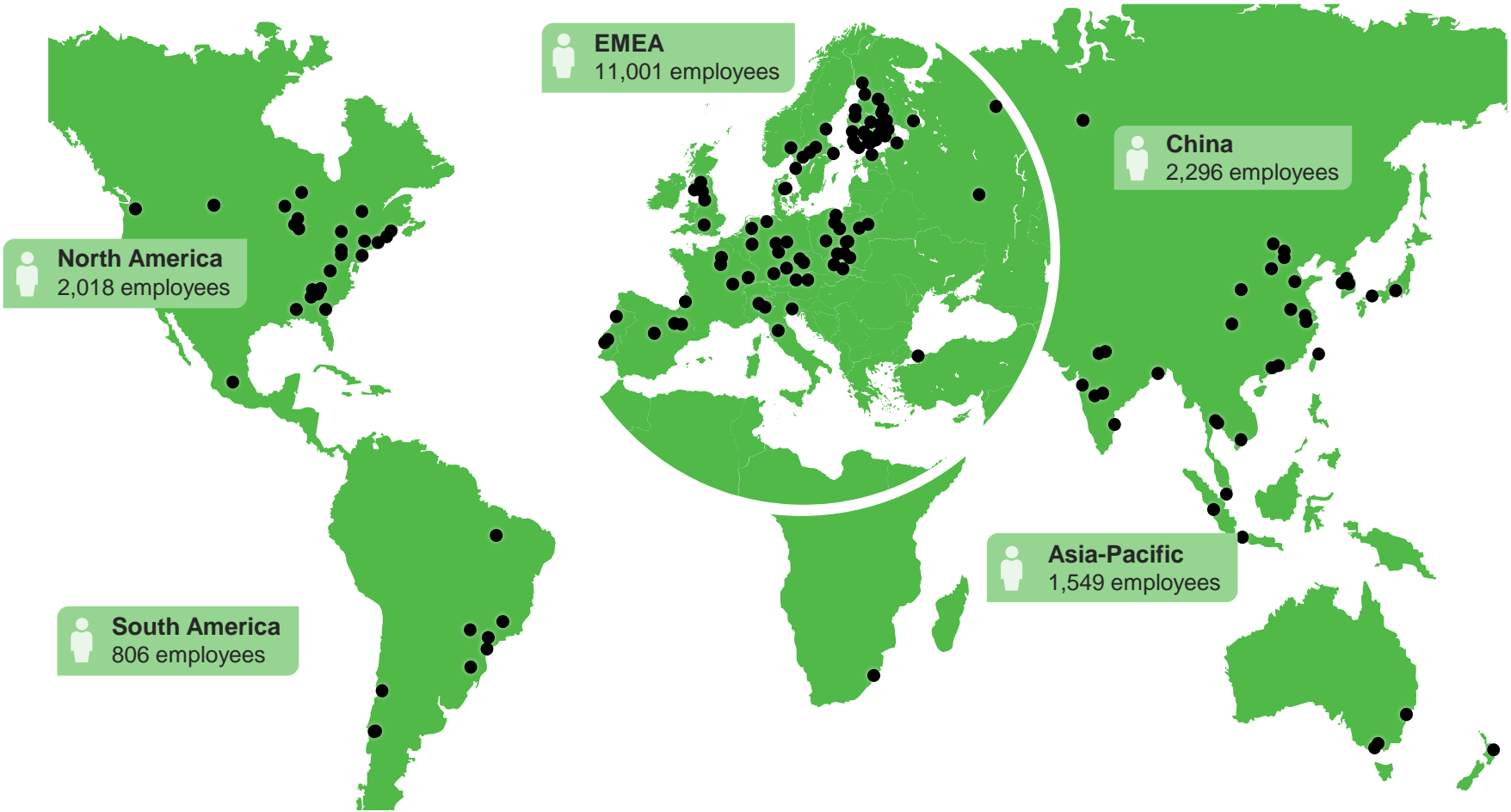

# Global presence creating a good platform for growth in Services and Automation



- ~140 service centers 
- 54 production units 
- 24 R&D centers 
- 8 Performance Centers 

Personnel as at June 30, 2022.

# Valmet's Way Forward

## Mission

Converting renewable resources into sustainable results

## Strategy

Valmet develops and supplies competitive and reliable process technologies, services and automation to the pulp, paper and energy industries.

Our automation business covers a wide base of global process industries.

We are committed to moving our customers' performance forward with our unique offering and way to serve.

## Continuous improvement and renewal

### Must-Wins

- Customer excellence
- Leader in technology and innovation
- Excellence in processes
- Winning team

### Business accelerators

## Vision

To become the global champion in serving our customers and in moving the industries forward

## Our Values



### Customers

We move our customers' performance forward



### Renewal

We promote new ideas to create the future



### Excellence

We improve every day to deliver results



### People

We work together to make a difference

## Megatrends

- Resource efficient and clean world
- Digitalization and new technologies
- Urban, responsible and global consumer



# Valmet's R&D is aiming to address global megatrends

## R&D focus areas

- Promotion of renewable materials
- Raw material, water and energy efficiency
- Emission reductions
- Circularity
- Productivity and environmental improvements with digitalization

**24**

research and  
development centers



EUR **98** million  
R&D spending  
in 2021



**~1,300**  
protected  
inventions

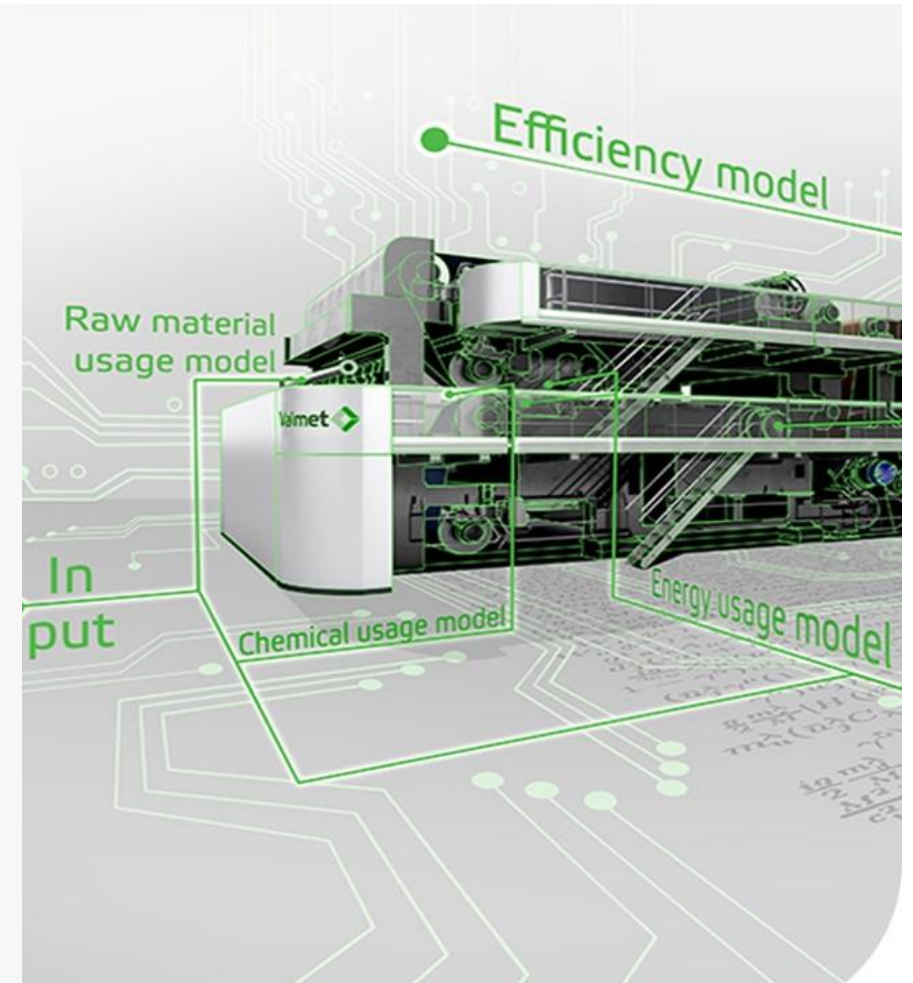

Illustrative figures of the combined company.

# Acknowledged leader in sustainability

360° approach to sustainability across value chain

## Good sustainability ratings

- In Dow Jones Sustainability Index for the eighth consecutive year
- AAA rating in the MSCI ESG Ratings assessment 2021
- Bronze Class 2022 Sustainability Award
- Achieved B rating in CDP's climate program ranking 2021



Member of  
**Dow Jones  
Sustainability Indices**  
Powered by the S&P Global CSA



**Sustainability Award  
Bronze Class 2022**  
**S&P Global**



**MSCI  
ESG RATINGS**  
**AAA**  
CCC B BB BBB A AA AAA



# Valmet's Climate Program: Forward to a carbon neutral future

## Targets by 2030 for the entire value chain

### SUPPLY CHAIN

**-20%**

CO<sub>2</sub> emission reduction

### OWN OPERATIONS

**-80%**

CO<sub>2</sub> emission reduction

### USE PHASE OF VALMET'S TECHNOLOGIES

**-20%**

Further reduced energy use  
of Valmet's current technologies

**100%**

Carbon neutral production

- Valmet's new Climate Program sets credible targets and concrete actions for 2030 for the entire value chain
- Program is aligned with the Paris Climate Agreement's 1.5-degree pathway and UN Sustainable Development Goals and approved by the Science Based Targets Initiative (SBTi)

### Main actions to reach targets by 2030

- Target CO<sub>2</sub> emission reductions from supply chain
- Reduce energy usage and use renewable fuels and CO<sub>2</sub> free electricity and district heating in own locations
- Improve energy efficiency of our existing process technology offering by 20%
- Develop existing and new technologies to enable carbon neutral production for our customers

# Financial targets aligned with Valmet's financial reporting structure

## Growth

Net sales for Services and Automation segments to grow over two times the market growth

Net sales for Process Technologies segment to exceed market growth

## Profitability

Comparable EBITA:  
12–14%

## ROCE

Comparable return on capital employed (ROCE) before taxes<sup>1</sup> at least 15%

## Dividend policy

Dividend payout at least 50% of net profit

<sup>1</sup>: Comparable ROCE before taxes = (profit before taxes + interests and other financial expenses +/- items affecting comparability) / (balance sheet total - non-interest-bearing liabilities (average for the period))



# Investment highlights

# Investment highlights

- 1 Strong position in the growing market of converting renewables
- 2 Unique offering combining process technology, services and automation
- 3 EUR 2.8 billion recurring and steadily growing stable business
- 4 Services: The widest offering and strong geographical presence
- 5 Flow Control: Strong and diversified offering across many process industries
- 6 Automation Systems: Maximizing efficiency and safety of our customers
- 7 Paper: World-class technology for packaging and hygiene needs
- 8 Pulp and Energy: Strong business with high market share and flexible cost structure
- 9 Systematically building the future with continuous improvement

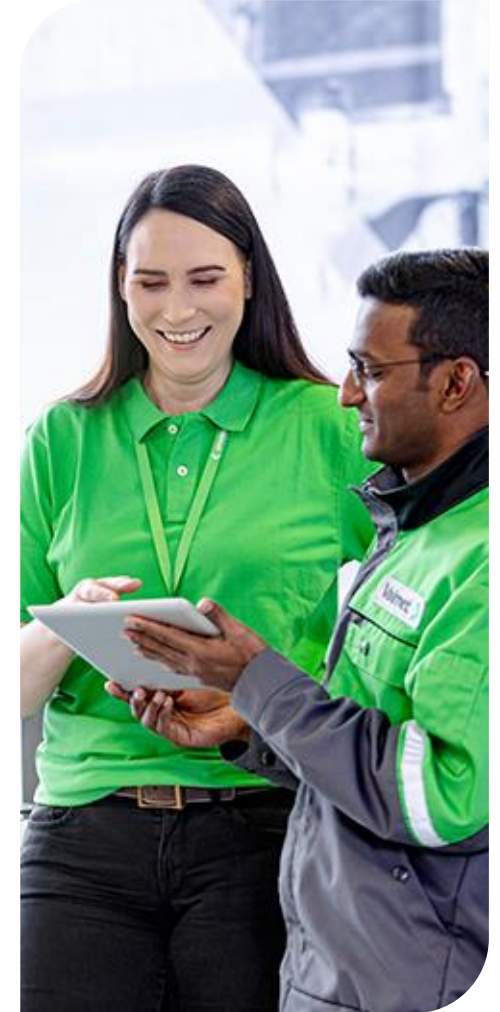



# Strong position in the growing market of converting renewables



Process Technologies



Services

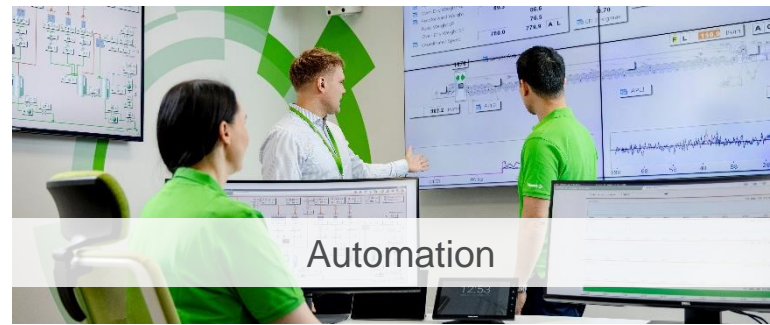

Automation

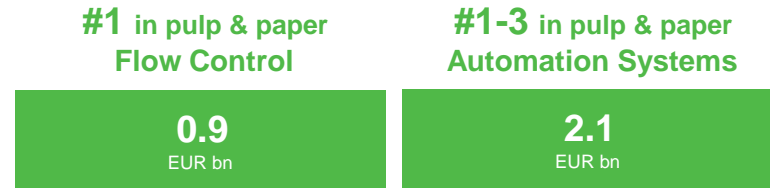
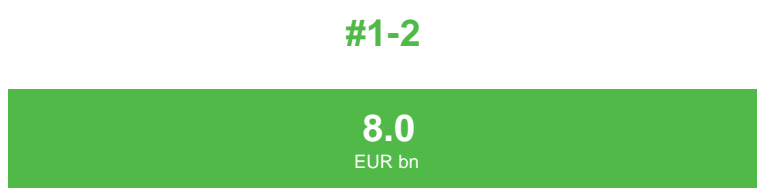

- World trade, e-commerce and emerging markets growth drive demand for packaging board
- Shift from plastic packaging to renewable materials
- Conversions from paper to board
- Rise in purchasing power and living standards drive tissue
- Urbanization and improved hygiene
- Fast economic growth in emerging markets
- Demand for higher quality
- Decarbonization in energy production
- Biomass and residual waste used in heat and process steam production
- Tightening air emissions legislation and stricter directives

- Increasing pulp, tissue, board and energy production
- Customer demand for resource efficiency, productivity, end-product quality and reduced environmental impact
- Customer focus on core, decreasing own resources and outsourcing
- Closures and conversions of non-competitive production lines

- Aging machines and installed automation systems
- Investments in new pulp and paper production lines and industrial decarbonization
- Demand for raw material savings, process efficiencies and sustainability
- Demand for Industrial Internet based solutions driven by customer digitalization

Net sales	Comparable EBITA	Comparable EBITA
<b>2,294</b>	<b>163</b>	<b>7.1%</b>
EUR million	EUR million	margin

Net sales	Comparable EBITA	Comparable EBITA
<b>1,455</b>	<b>209</b>	<b>14.4%</b>
EUR million	EUR million	margin

Net sales	Comparable EBITA	Comparable EBITA
<b>1,133</b>	<b>198</b>	<b>17.4%</b>
EUR million	EUR million	margin

# Market position   ■ Estimated market size for current offering (EUR)   ■ Market drivers   ■ Key financial figures (LTM Q2/2022). Automation segment: Figures are illustrative and include Neles figures from Q3/2021-Q1/2022.



# Unique offering combining process technology, services and automation

## Paper

- Board, paper and tissue production lines
- Rebuilds
- Stand-alone products

## Pulp

- Wood and pulp handling
- Fiber processing
- Recovery

## Energy

- Heat and power generation
- Air emission control
- Biofuels

## Services

- Spare parts and components
- Maintenance and shutdown services
- Outsourcing services
- Production consumables
- Process support and optimization

## Flow Control and Automation Systems

- Valves
- Valve automation
- Valve controls
- Distributed control systems (DCS)
- Quality management systems (QMS)
- Analyzers and measurements
- Services and Industrial Internet solutions



# EUR 2.8 billion recurring and steadily growing stable business

**Orders received**  
(EUR million)

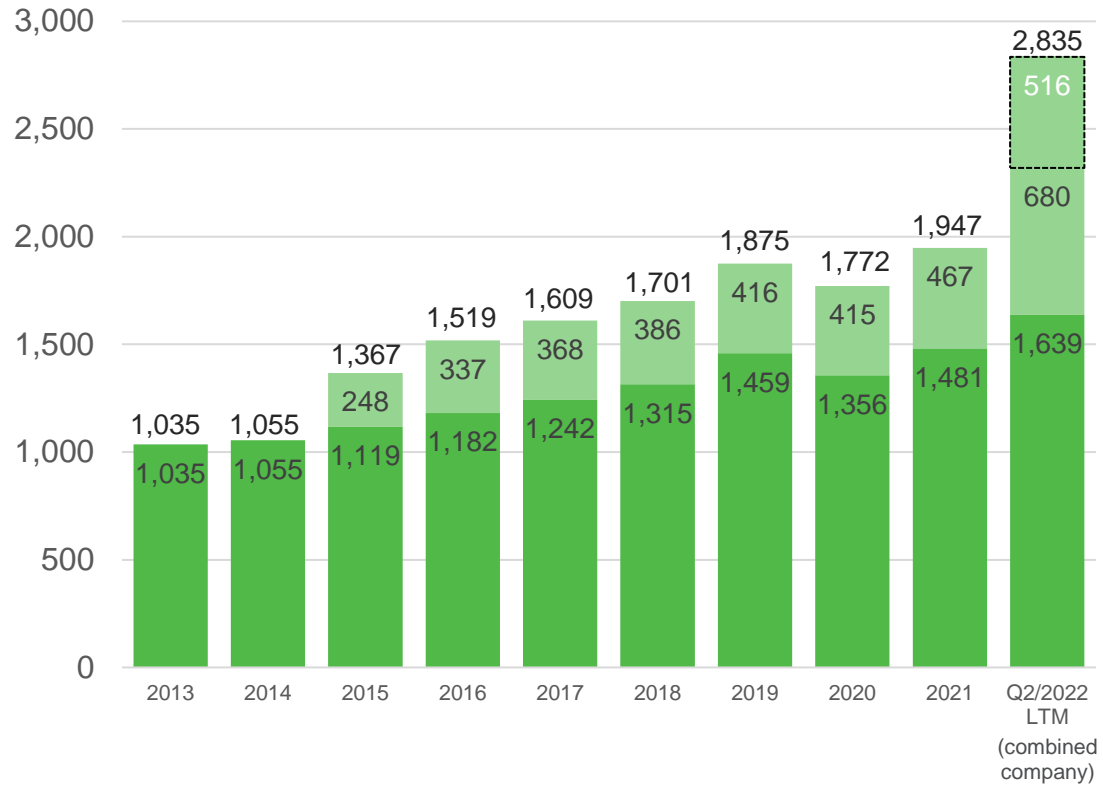

- Valmet’s stable business has grown steadily since 2014
- Future growth possibilities are supported by favorable megatrends
- Stable business provides resilience to business cycles and makes Valmet’s order intake less cyclical

Figures in dark green for Valmet Services segment, light green for Valmet Automation segment. For Q2/2022 LTM (combined company), figures are illustrative, and the light green outlined in black illustrates Flow Control business line Q3/2021-Q1/2022 (i.e., Neles figures). 2013-2020 figures have not been restated.

# Services: The widest offering and strong geographical presence

## Services business line

- Widest offering to support customers' all service needs
- Benefits from growing installed base
- Strong geographical presence close to customers
- Steady increase in market share from 13% in 2014 to 17–18% in 2020
- Targeting to grow with the market and by winning further market share
- Opportunities to win new customers and increase share of wallet with existing customers

### Services business line

Orders received (EUR million)

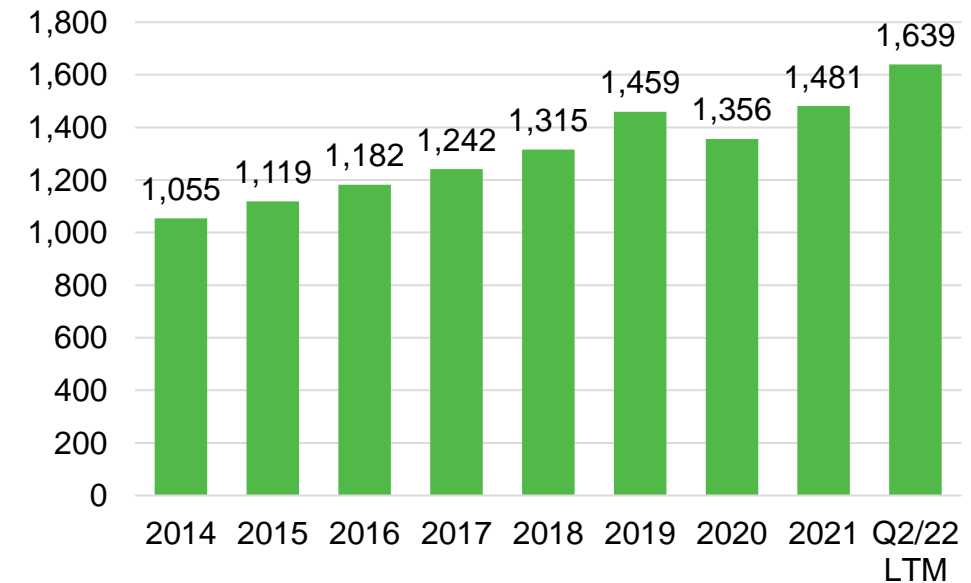

Organic growth  
~4%  
CAGR in  
2014-2019

# Flow Control: Strong and diversified offering across many process industries

## Flow control business line

- Leading position as a flow control solution provider
- Market leadership in pulp & paper and industrial gases
- A leading global player in downstream oil & gas and petrochemical
- Market leadership in valve controls
- Proven track record of profitable growth and resilient business through economic cycles
- Diversified sales mix by region, customer and industry
- Continued growth in existing and new industries such as metals & mining and renewable energy
- Growing both organically and through selected acquisitions

### Flow Control business line

Orders received (EUR million)

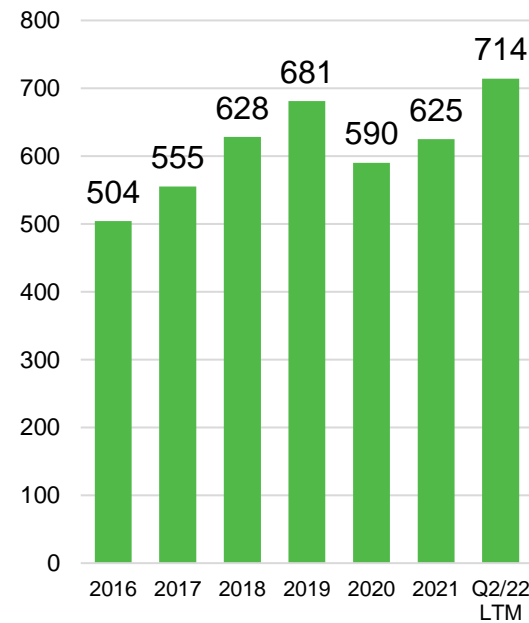

Sales by industry (%), 2021

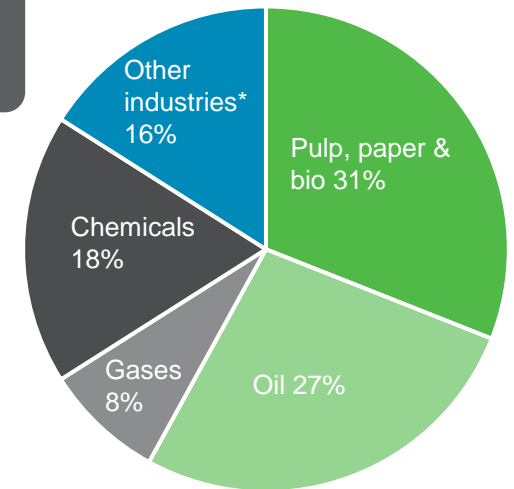

# Automation Systems: Maximizing efficiency and safety of our customers

## Automation Systems business line

- Solutions range from single measurements to plant-wide process automation systems
- Designed to maximize safety, sustainability and efficiency of customers' businesses
- Securing future competitiveness with R&D
- Strong track record since acquired to Valmet in 2015
- Several drivers for future growth
  - Increasing direct sales to customers
  - Package sales with Valmet's capital equipment
  - Replacing competitors' installed base and entering new industries
  - Growing in automation services

## Automation Systems business line

Orders received (EUR million)

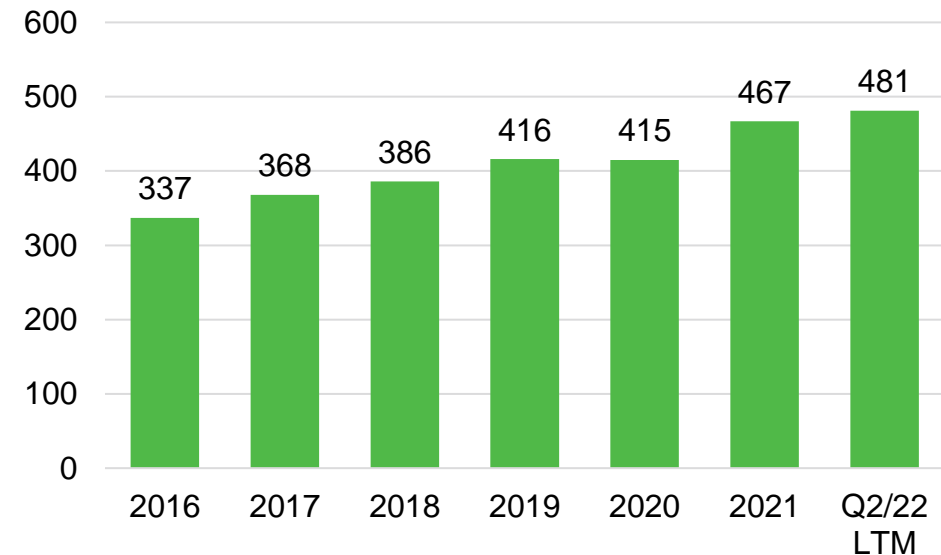

Organic growth  
~7%  
CAGR



# Paper: World-class technology for packaging and hygiene needs

## Paper business line

- Offering includes world-leading technology and products for board, tissue and paper making
- Long-term growth supported by favorable megatrends
  - Growing e-commerce and packaging needs
  - Increasing demand for hygiene products
- High market share
- Technological advantage and excellent references
- R&D targeted to introduce new products and improve the existing offering
- Flexible organization and low capacity costs provide resilience to market fluctuations

## Paper business line

Orders received (EUR million)

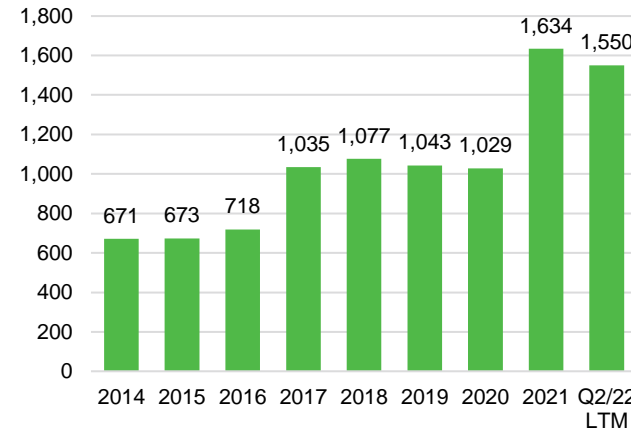

Net sales (EUR million)

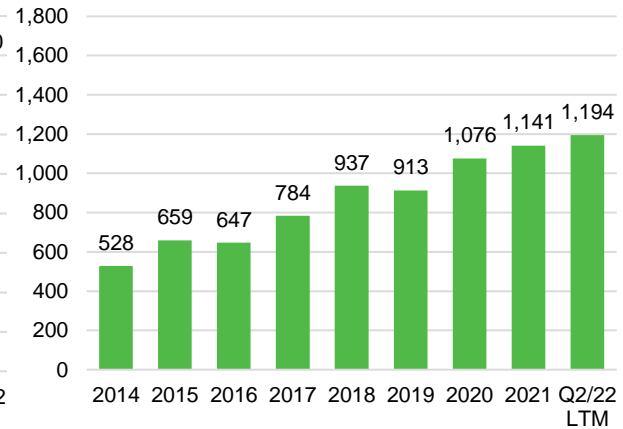

Capacity costs	2015	2021
EUR million	270	343
% of net sales	41%	29%

	Market share	Market position
Board	~50%	#1
Tissue	~35%	#1
Paper	~50%	#1

# Pulp and Energy: Strong business with high market share and flexible cost structure

## Pulp and Energy business line

- Offering includes full pulp mills and energy solutions for biomass and emission control
- Long-term growth supported by favorable megatrends
  - Growing demand for sustainable packaging and hygiene products and textiles
  - Replacing plastic with fiber-based materials
- High market share
- Technological advantage by focusing on R&D
- Flexible organization and low capacity cost provides resilience to market fluctuations
- Yearly variations in orders received are typical due to timing of large orders

### Pulp and Energy business line

Orders received (EUR million)

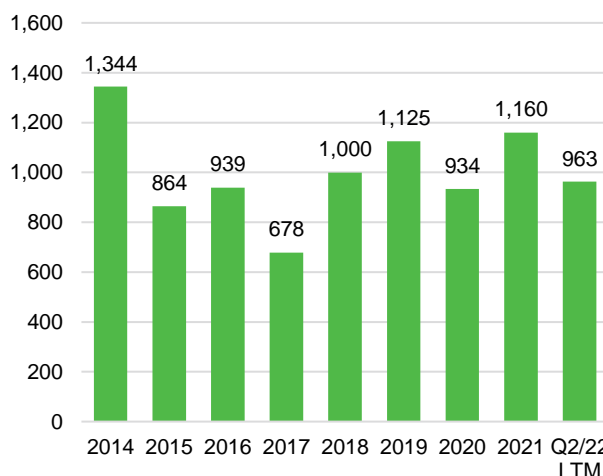

Net sales (EUR million)

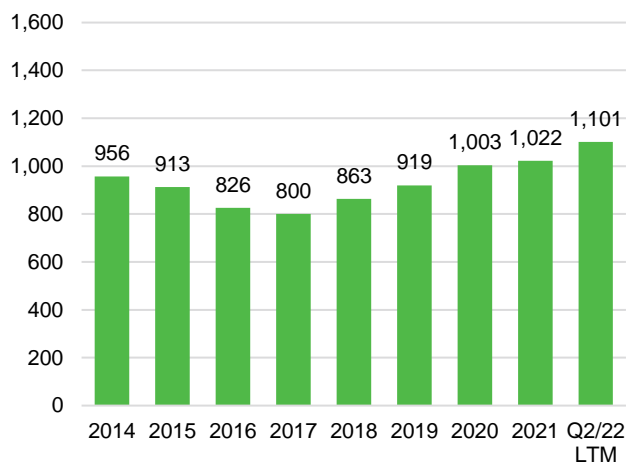

Capacity costs	2015	2021
EUR million	218	206
% of net sales	24%	20%

	Market share	Market position
Pulp	~45%	#1-2
Energy	~20%	#1-3

2014-2020 figures have not been restated. For pulp and energy, the market position and market share calculated based on 2020 figures.



# Systematically building the future with continuous improvement



## Customer

Valmet's way to serve:  
Lifecycle collaboration  
between the customer  
and Valmet

Add value to customers  
through Industrial  
Internet solutions

Ensure strong market  
position in capital  
business

Continue to increase  
market share in the  
stable business



## Technology

Develop new products  
and technologies

- Molded fibre
- Recycled textile fibre
- Lignoboost
- Cellulose based textile fiber

Improve product cost  
competitiveness

Increase material and  
energy efficiency and  
further develop solutions  
to reduce carbon  
footprint



## Process

Continue to improve  
project management  
and project execution

Valmet's climate  
program targeting to  
reduce emissions in the  
whole value chain



## People

Continuous development  
of employees through  
training programs

Building capabilities  
globally

Continue to improve  
safety and lower LTIF<sup>1</sup>

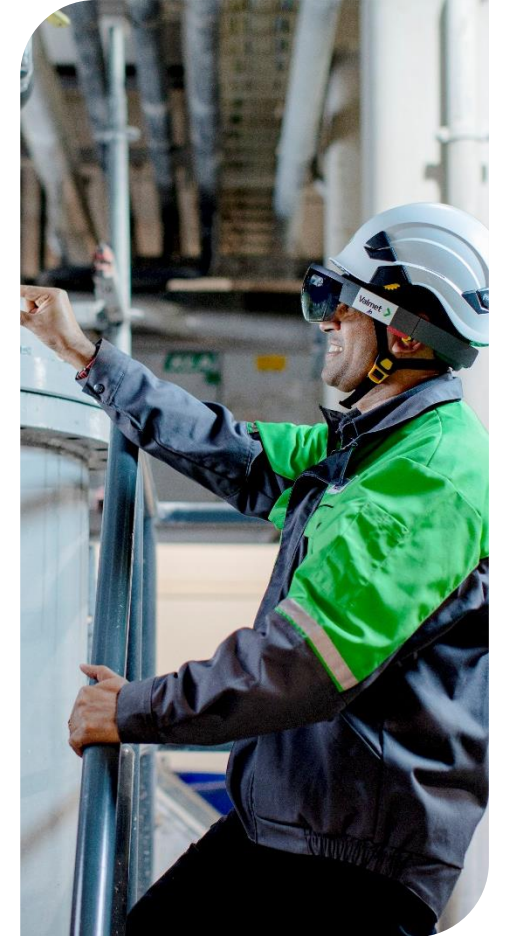

1) LTIF = Lost time incident frequency.



# Financials

# Key figures

EUR million	Q2/2022	Q2/2021	Change	Q1–Q2/2022	Q1–Q2/2021	Change
Orders received	<b>1,306</b>	1,228	6%	<b>2,631</b>	2,540	4%
Order backlog <sup>1</sup>	<b>4,784</b>	4,019	19%	<b>4,784</b>	4,019	19%
Net sales	<b>1,286</b>	943	36%	<b>2,246</b>	1,801	25%
Comparable EBITA	<b>122</b>	95	29%	<b>202</b>	175	15%
% of net sales	<b>9.5%</b>	10.1%	-0.5 pp	<b>9.0%</b>	9.7%	-0.7 pp
EBITA	<b>154</b>	97	59%	<b>229</b>	186	23%
Operating profit (EBIT)	<b>120</b>	85	42%	<b>183</b>	161	14%
% of net sales	<b>9.4%</b>	9.0%	0.4 pp	<b>8.2%</b>	8.9%	-0.8 pp
Adjusted earnings per share, EUR <sup>2</sup>	<b>0.68</b>	0.45	51%	<b>1.05</b>	0.86	21%
Earnings per share, EUR	<b>0.55</b>	0.43	28%	<b>0.87</b>	0.81	8%
Return on capital employed (ROCE) before taxes <sup>3</sup>				<b>15%</b>	20%	-5 pp
Cash flow provided by operating activities	<b>-85</b>	180		<b>-65</b>	328	
Gearing <sup>1</sup>				<b>22%</b>	-1%	22 pp

Items affecting comparability: EUR 32 million in Q2/2022 (EUR 2 million in Q2/2021) and EUR 27 million in Q1-Q2/2022 (EUR 11 million in Q1-Q2/2021).

During Q2/2022 items affecting comparability included EUR 59 million gain from remeasurement of Valmet's previously held equity interest in Neles and expenses from Valmet's withdrawal from Russia.

1) At end of period

2) Adjusted earnings per share is a new alternative performance measure that excludes the impact of fair value adjustments arising from business combinations, net of tax

3) Annualized

# Segment key figures

Orders received, EUR million	Q2/2022	Q2/2021	Change	Q1–Q2/2022	Q1–Q2/2021	Change
Services	460	370	24%	911	752	21%
Automation	305	116	>100%	452	239	89%
Process Technologies	542	742	-27%	1,268	1,549	-18%
Total	1,306	1,228	6%	2,631	2,540	4%

Net sales, EUR million	Q2/2022	Q2/2021	Change	Q1–Q2/2022	Q1–Q2/2021	Change
Services	403	337	20%	720	625	15%
Automation	292	94	>100%	380	161	>100%
Process Technologies	591	512	15%	1,146	1,015	13%
Total	1,286	943	36%	2,246	1,801	25%

Comparable EBITA, EUR million	Q2/2022	Q2/2021	Change	Q1–Q2/2022	Q1–Q2/2021	Change
Services	57	47	22%	88	83	6%
Automation	50	15	>100%	60	20	>100%
Process Technologies	31	41	-24%	71	84	-15%
Other	-15	-8	-89%	-18	-12	-53%
Total	122	95	29%	202	175	15%

  

Comparable EBITA margin, % of net sales	Q2/2022	Q2/2021	Change	Q1–Q2/2022	Q1–Q2/2021	Change
Services	14.2%	13.9%	0.3 pp	12.2%	13.3%	-1.1 pp
Automation	17.0%	16.4%	0.6 pp	15.9%	12.6%	3.3 pp
Process Technologies	5.2%	8.0%	-2.7 pp	6.2%	8.2%	-2.0 pp
Total	9.5%	10.1%	-0.5 pp	9.0%	9.7%	-0.7 pp



# Comparable EBITA margin development

Net sales and Comparable EBITA (EUR million and %)<sup>1</sup>

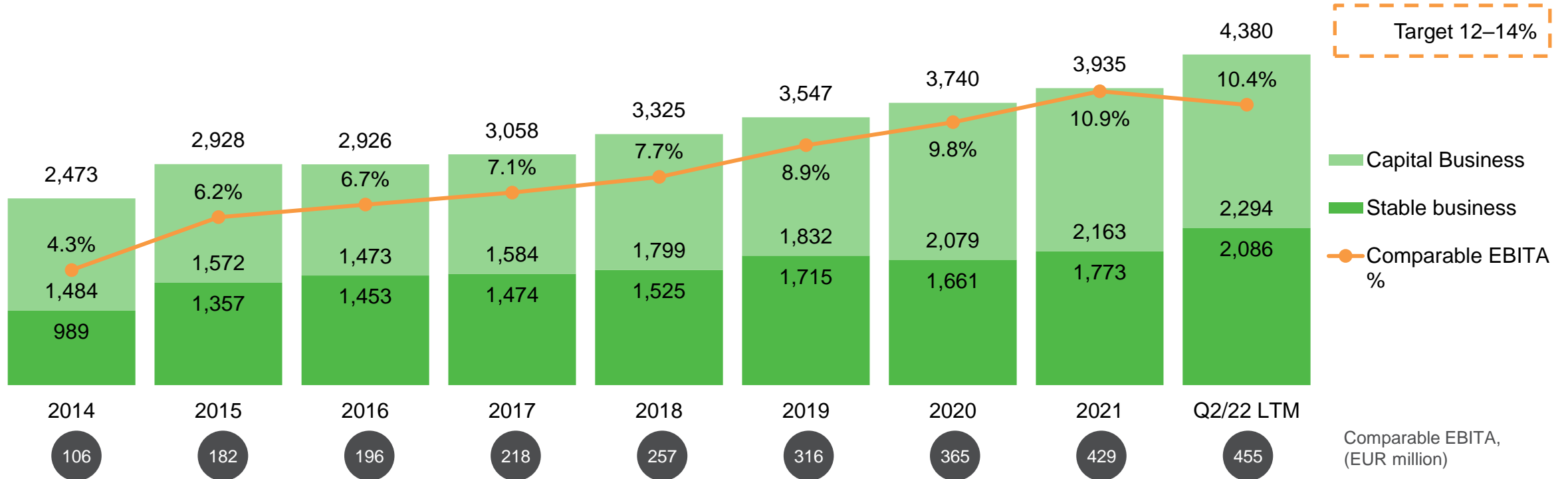

1) Valmet implemented IFRS 15 – Revenue from Contracts with Customers as of January 1, 2018 by applying full retrospective method. 2014-2020 figures have not been restated to reflect Valmet's current reporting structure. Thus, figures presented are not fully comparable.

# Guidance and short-term market outlook

Guidance for 2022 (Published on April 1, 2022)

<b>Guidance</b>	<p>Valmet estimates that, including the merger with Neles, net sales in 2022 will increase in comparison with 2021 (EUR 3,935 million) and Comparable EBITA in 2022 will increase in comparison with 2021 (EUR 429 million).</p>
-----------------	--

## Short-term market outlook

		Q3/2021	Q4/2021	Q1/2022	Q2/2022
Services		Good	Good	Good	Good
Automation	Flow Control		Good	Good	Good
	Automation Systems	Good	Good	Good	Good
Pulp and Energy	Pulp	Good	Good	Good	Good / Satisfactory
	Energy	Weak	Satisfactory	Satisfactory	Good
Paper	Board and Paper	Good	Good	Good	Good
	Tissue	Satisfactory	Satisfactory	Satisfactory	Satisfactory

The short-term market outlook is based on customer activity (50%) and Valmet's capacity utilization (50%) and is given for the next six months from the end of the respective quarter. The scale is 'weak-satisfactory-good'.



# Summary

# Investment highlights

- 1 Strong position in the growing market of converting renewables
- 2 Unique offering combining process technology, services and automation
- 3 EUR 2.8 billion recurring and steadily growing stable business
- 4 Services: The widest offering and strong geographical presence
- 5 Flow Control: Strong and diversified offering across many process industries
- 6 Automation Systems: Maximizing efficiency and safety of our customers
- 7 Paper: World-class technology for packaging and hygiene needs
- 8 Pulp and Energy: Strong business with high market share and flexible cost structure
- 9 Systematically building the future with continuous improvement

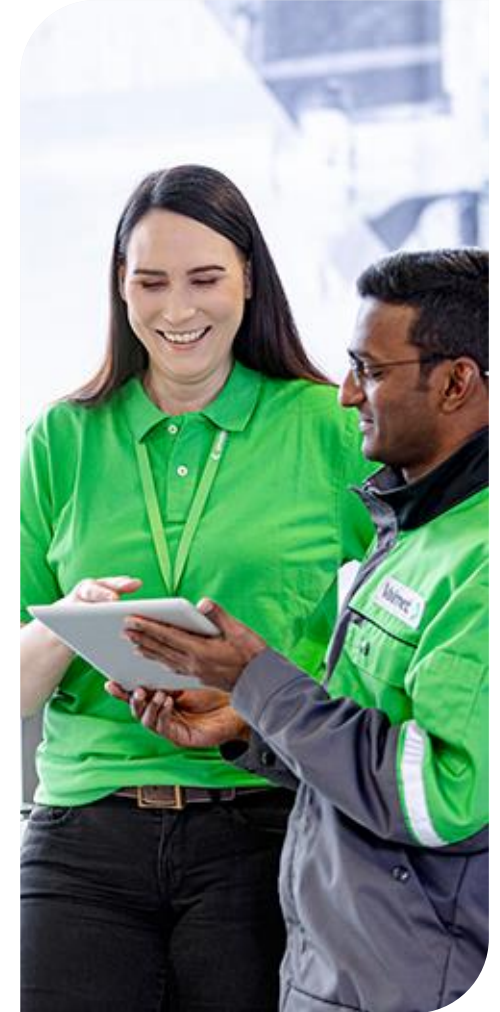

# Important notice

It should be noted that certain statements herein which are not historical facts, including, without limitation, those regarding expectations for general economic development and the market situation, expectations for growth, profitability and investment willingness, expectations for company development, growth and profitability and the realization of synergy benefits and cost savings, and statements preceded by “anticipates”, “believes”, “estimates”, “expects”, “foresees” or similar expressions, are forward-looking statements. Since these statements are based on current decisions and plans, estimates and projections, they involve risks and uncertainties which may cause the actual results to materially differ from the results currently expressed. Such factors include, but are not limited to:

- 1) general economic conditions, including fluctuations in exchange rates and interest levels which influence the operating environment and profitability of customers of the company or economic growth in the company’s principal geographic markets.
- 2) industry conditions, intensity of competition situation, especially potential introduction of significant technological solutions developed by competitors, financial condition of the customers and the competitors of the company,
- 3) the company’s own operating factors, such as the success of production, product development and project management and the efficiencies therein including continuous development and improvement
- 4) the success of pending and future acquisitions and restructuring.



# Appendix

1 Financials

2 Growth and profitability improvement

3 Shareholders and share price development

4 Strategy and offering

5 Management and remuneration





Appendix  
**Financials**

# Quarterly Comparable EBITA margin development

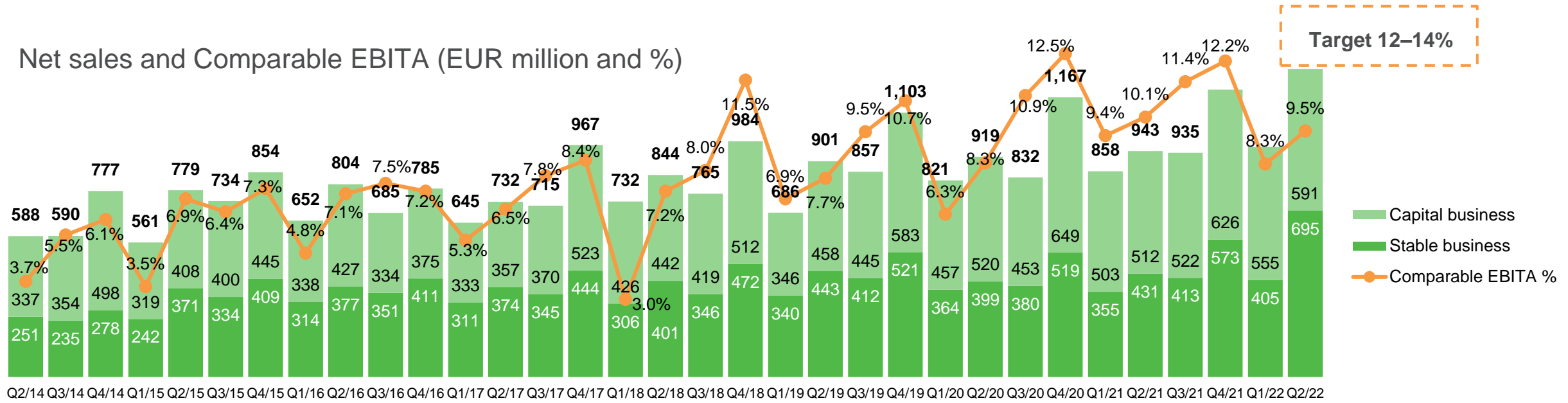

Comparable EBITA (EUR million)

# Services: Orders received increased to EUR 911 million in H1/2022

Orders received (EUR million)

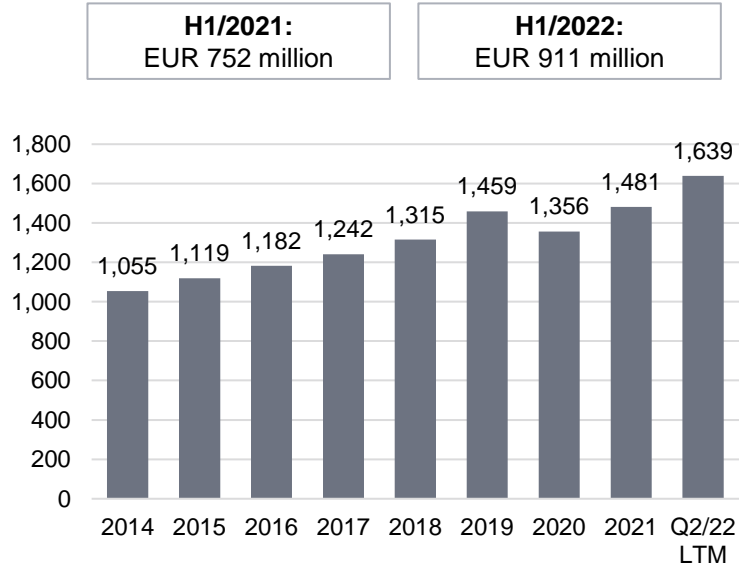

Net sales (EUR million)

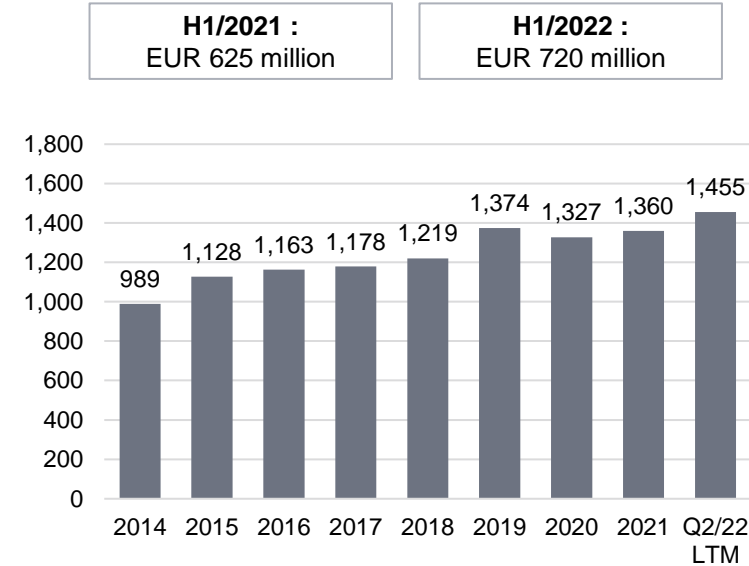

Comparable EBITA (EUR million and % of net sales)

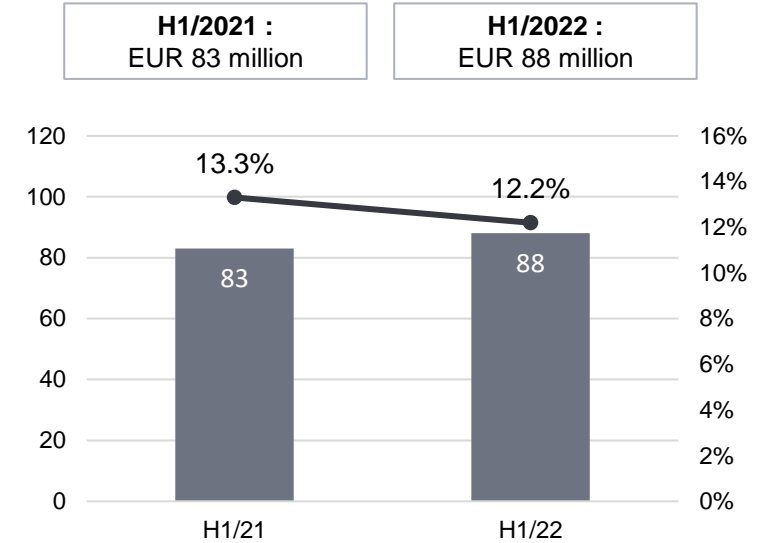

- Orders received increased compared with H1/2021
  - Orders received increased in all geographical areas
  - Orders received increased in all businesses
- Net sales increased compared with H1/2021
- Comparable EBITA increased compared with H1/2021 due to higher net sales, but the margin was lower due to cost inflation
- COVID-19 related travel restrictions in Asia and the lockdown in China impacted Services' business environment during H1/2022
- Services segment was affected by cost inflation, reduced component availability and longer delivery times of certain components in H1/2022



# Automation: Orders received increased to EUR 452 million in H1/2022

Automation segment includes Automation Systems and starting from Q2/2022 also Flow Control

Orders received (EUR million)

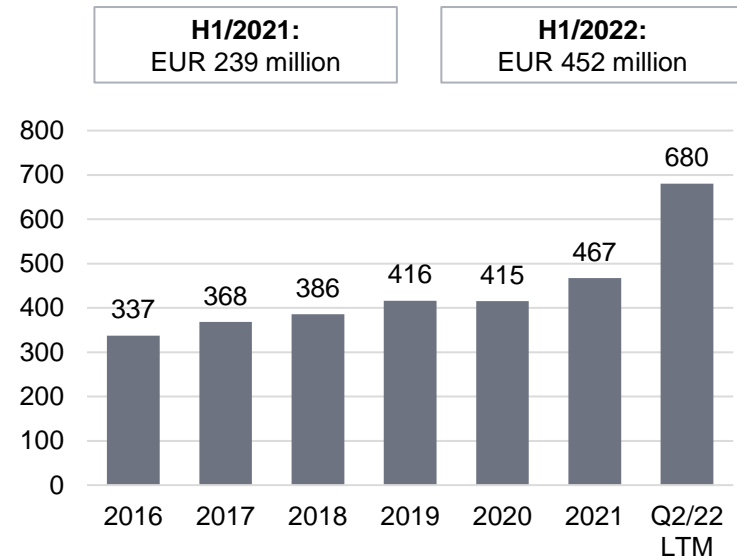

Net sales (EUR million)

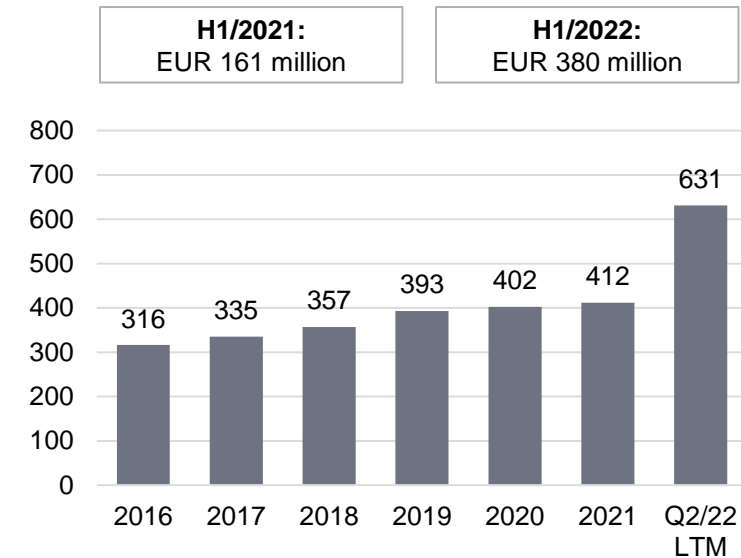

Comparable EBITA (EUR million and % of net sales)

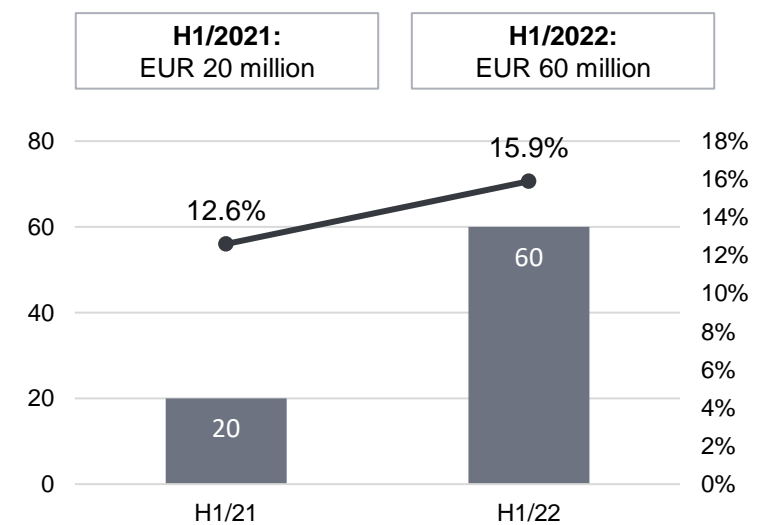

- Orders received increased compared with H1/2021
- Net sales increased compared with H1/2021
- Comparable EBITA increased compared with H1/2021 mainly due to consolidation of Flow Control into Valmet



# Flow Control: Strong start as part of Valmet

Orders received (EUR million)\*

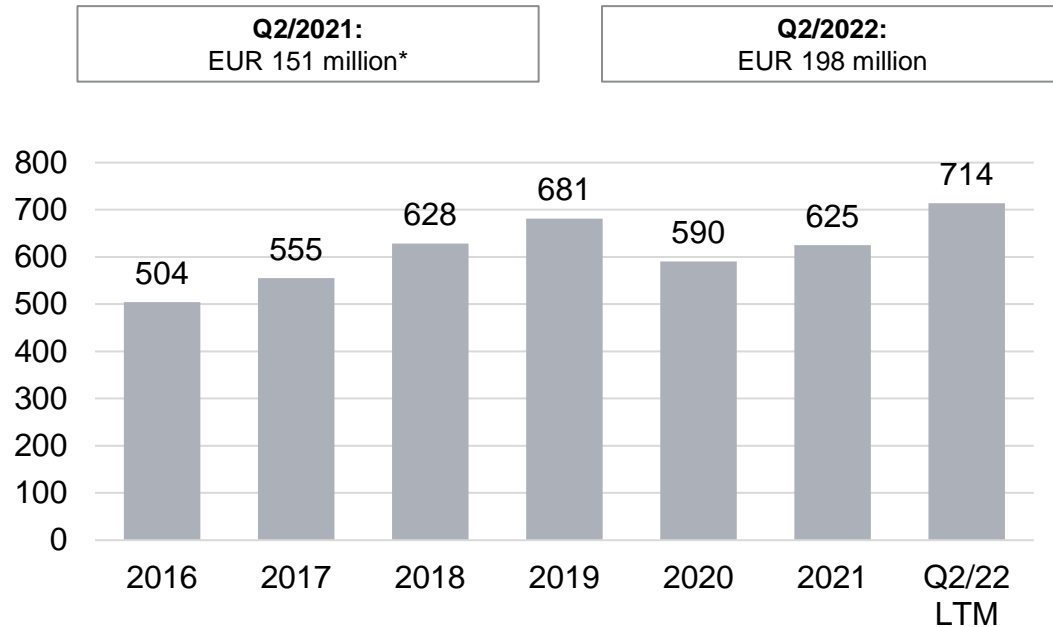

Net sales (EUR million)\*

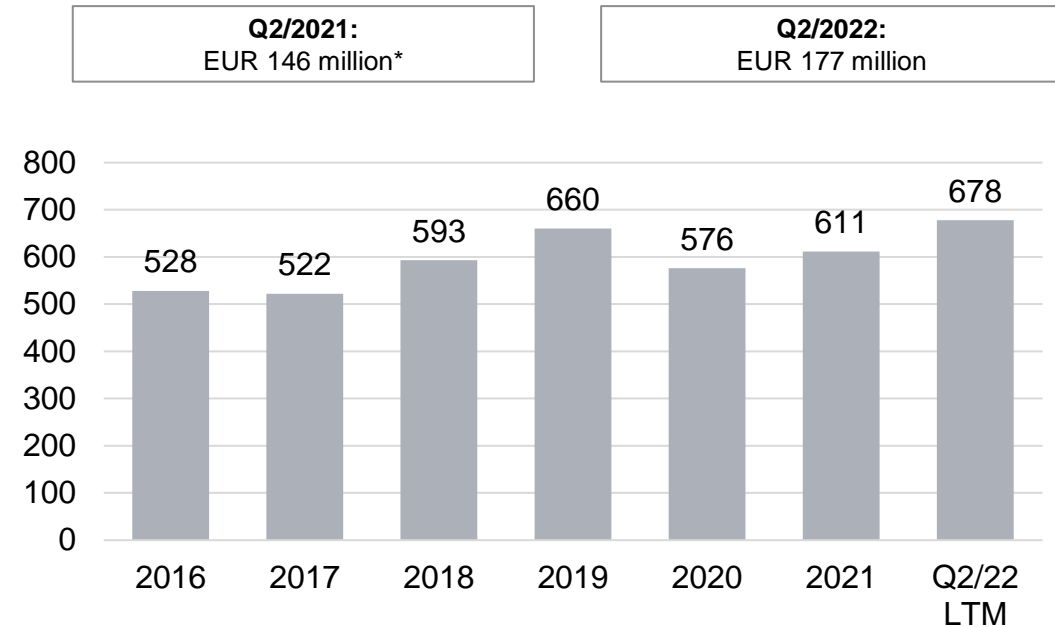

- Orders received amounted to EUR 198 million in Q2/2022
  - Orders received increased\* in all geographical areas
- Net sales amounted to EUR 177 million in Q2/2021
- The lockdown in China and the war in Ukraine impacted Flow Control's business environment in Q2/2022
- Component availability continues at a reduced level and delivery times of certain components were longer during Q2/2022



\* 2016-2017 financials based on carve-out numbers; 2018-2019 financials based on Metso's "Continuing operations" as in 2019 annual report; Q1/2020-Q1/2022 financials as reported in Neles' Q1/2022 interim review.

# Automation Systems: Orders received increased to EUR 253 million in H1/2022

Orders received (EUR million)

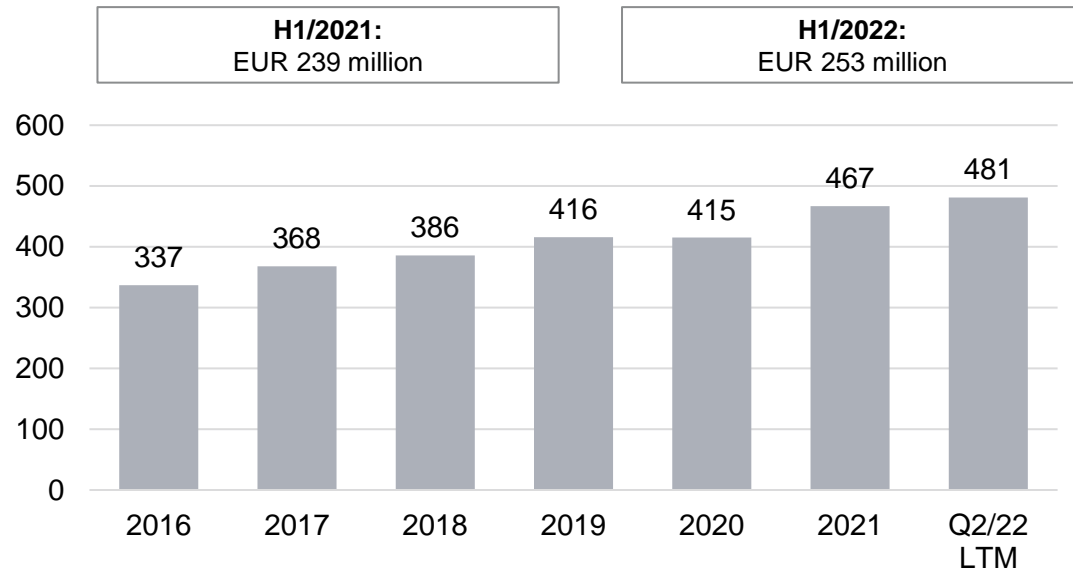

Net sales (EUR million)

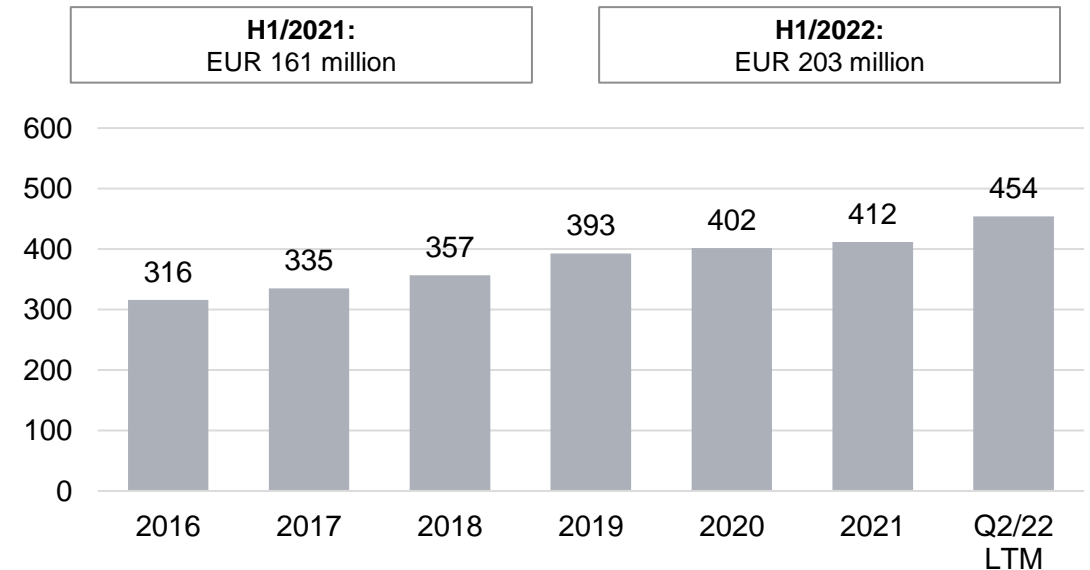

- Orders received increased compared with H1/2021
  - Orders received increased in North America and Asia-Pacific, remained at the previous year's level in EMEA, and decreased in South America and China
  - Orders received remained at the previous year's level in Pulp and Paper, and increased in Energy and Process
- Net sales increased compared with H1/2021
- COVID-19 related travel restrictions and lockdowns in China impacted Automation Systems' business environment during H1/2022
- Component availability continues at a reduced level and delivery times of certain components were longer during H1/2022



# Process Technologies: Orders received decreased to EUR 1,268 million in H1/2022

Orders received (EUR million)

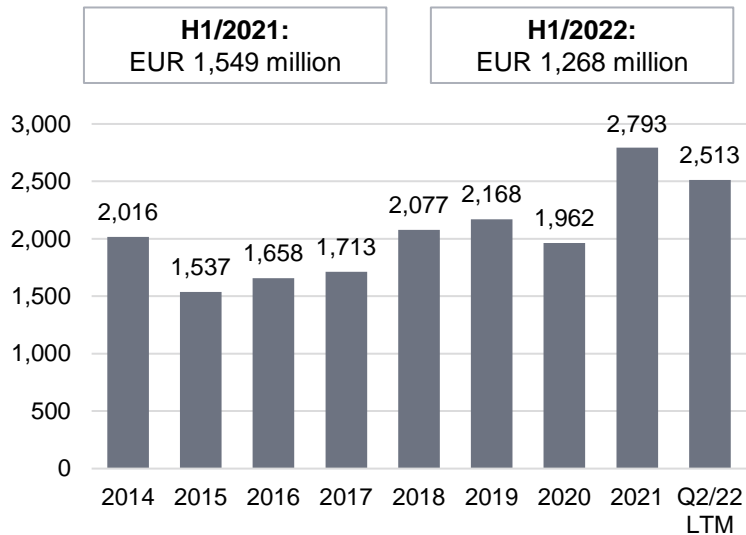

Net sales (EUR million)

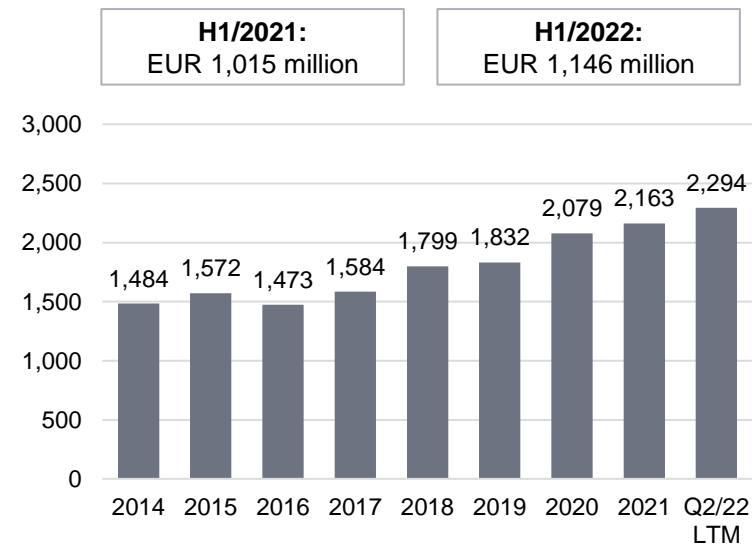

Comparable EBITA (EUR million and % of net sales)

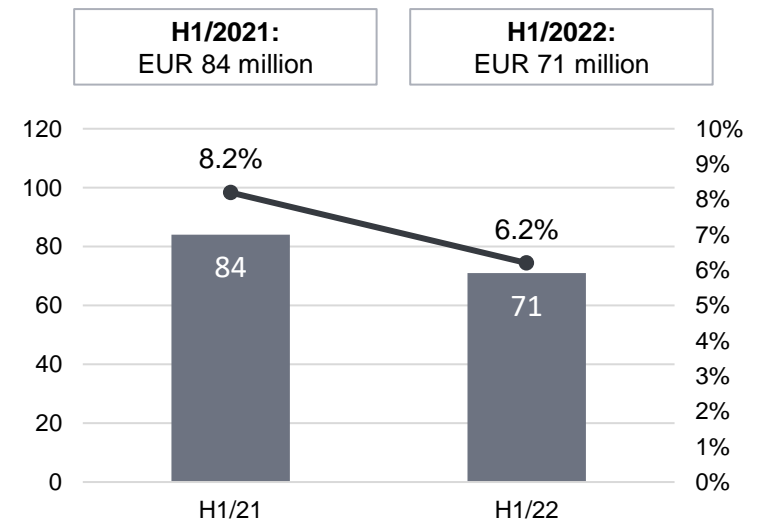

- Orders received decreased compared with H1/2021
- Net sales increased compared with H1/2021
- Comparable EBITA decreased compared with H1/2021, as the margins in some Pulp and Energy projects were impacted by cost inflation





# Pulp and Energy business line: Orders received decreased to EUR 581 million in H1/2022

Orders received (EUR million)

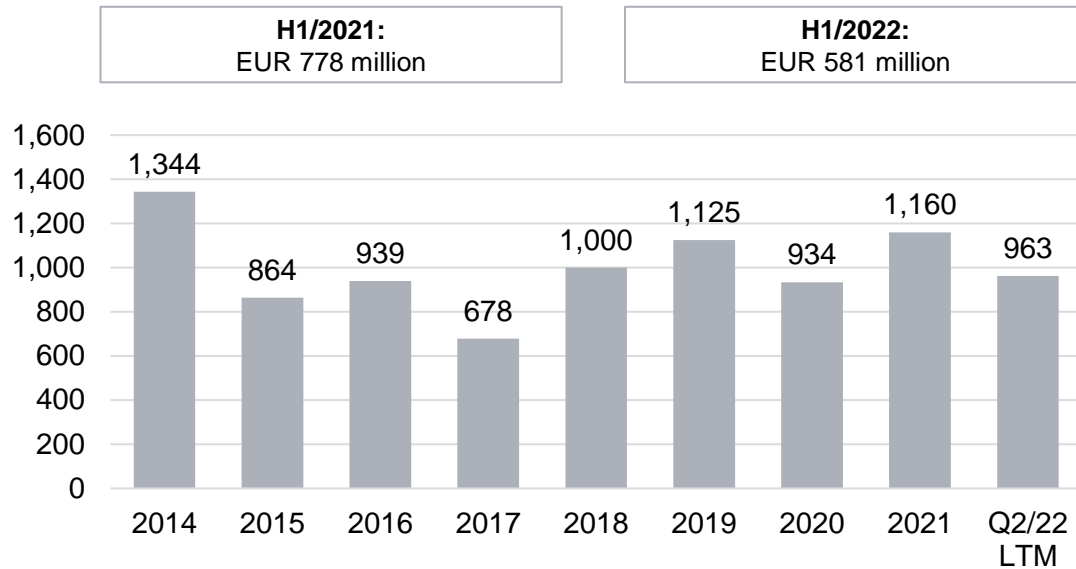

Net sales (EUR million)

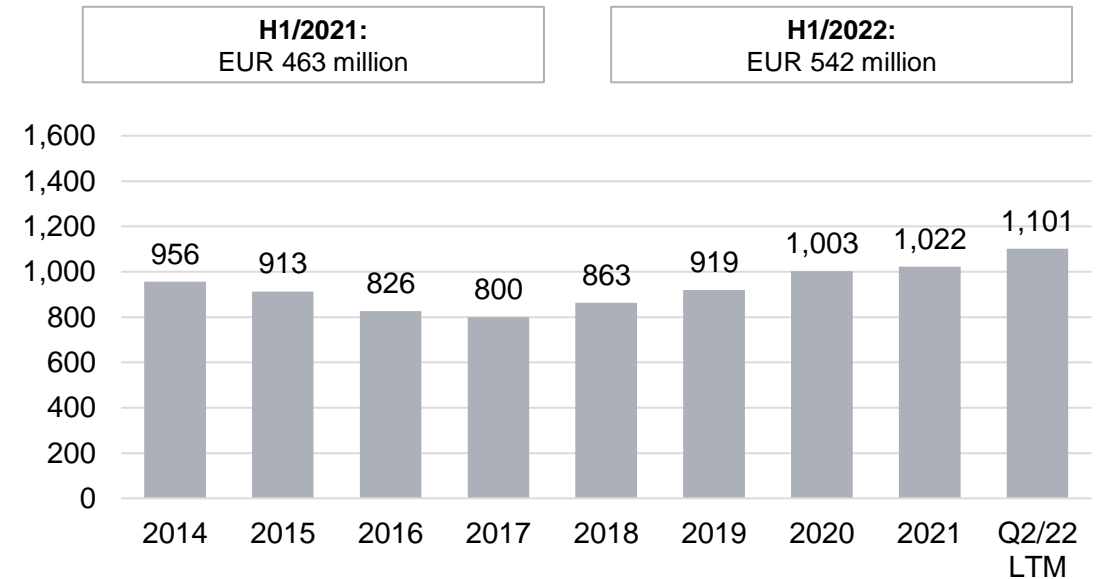

- Orders received decreased compared with H1/2021
  - Orders received increased in North America and Asia-Pacific and decreased in China, South America and EMEA
  - Orders received decreased in Pulp and increased in Energy
- Net sales increased compared with H1/2021
- Cost inflation impacted Pulp & Energy's business environment during H1/2022
- The Pulp and Energy business line has managed the challenges caused by COVID-19 well, and the pandemic did not cause major impacts on its operations during H1/2022



# Paper business line: Orders received decreased to EUR 688 million in H1/2022

Orders received (EUR million)

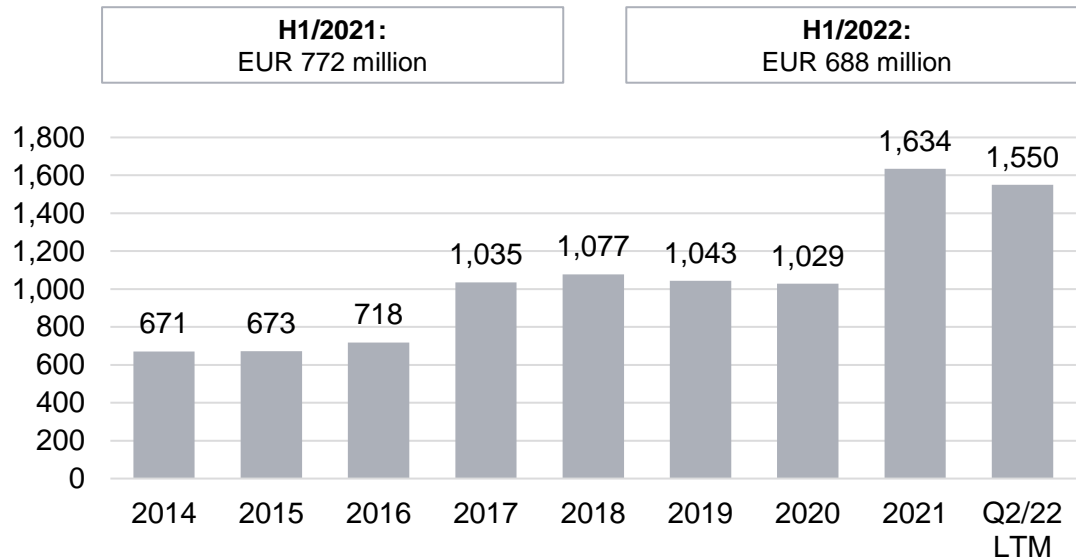

Net sales (EUR million)

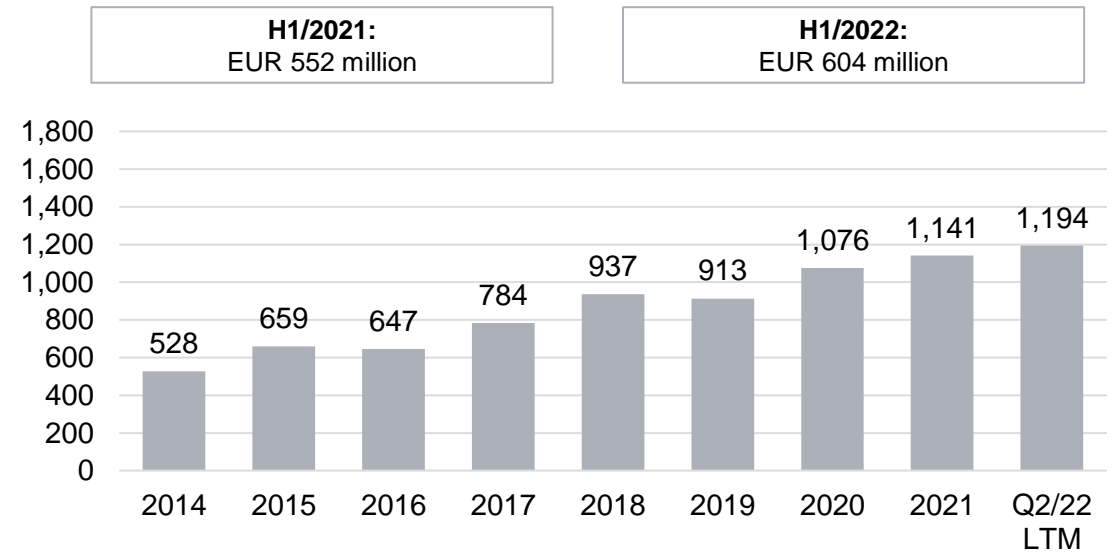

- Orders received decreased compared with H1/2021
  - Orders received increased in Asia-Pacific, North America and EMEA, and decreased in South America and China
  - Orders received decreased in Board and Paper, but increased in all other businesses
- Net sales increased compared with H1/2021
- The fire at Rautpohja factory site in Finland, COVID-19 and lockdowns in China impacted Paper business line's operations during Q2/2022
- The Paper business line has managed the challenges caused by the fire and COVID-19 well

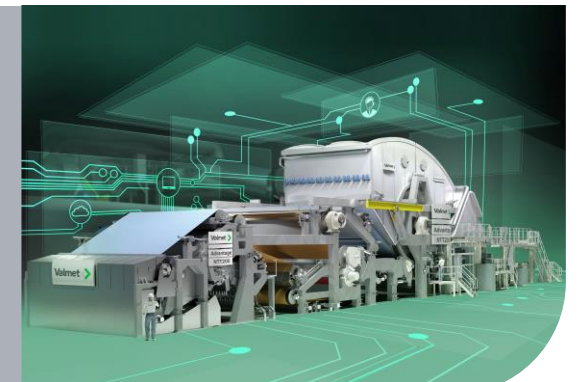

# Orders received and net sales split in 2021

Orders received (EUR million and % of total)

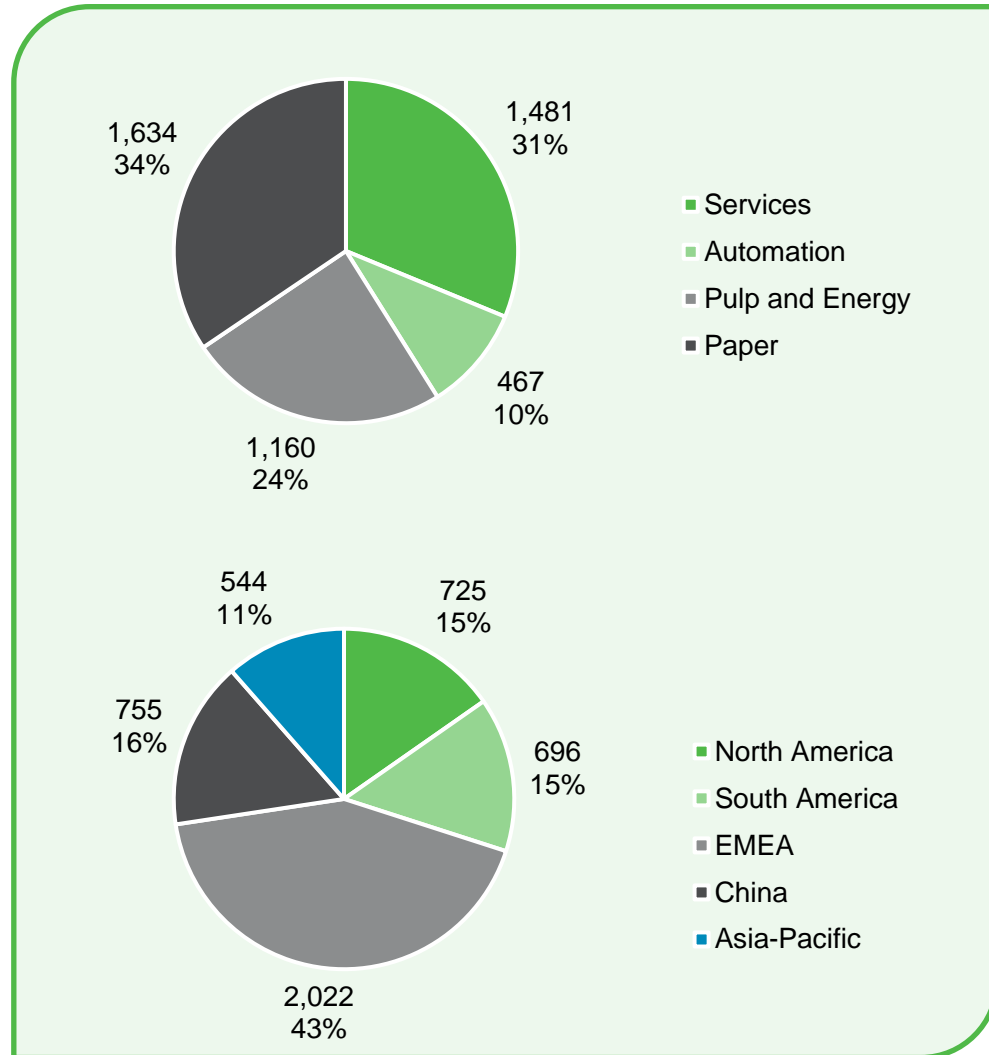

Business line figures restated.

Net sales (EUR million and % of total)

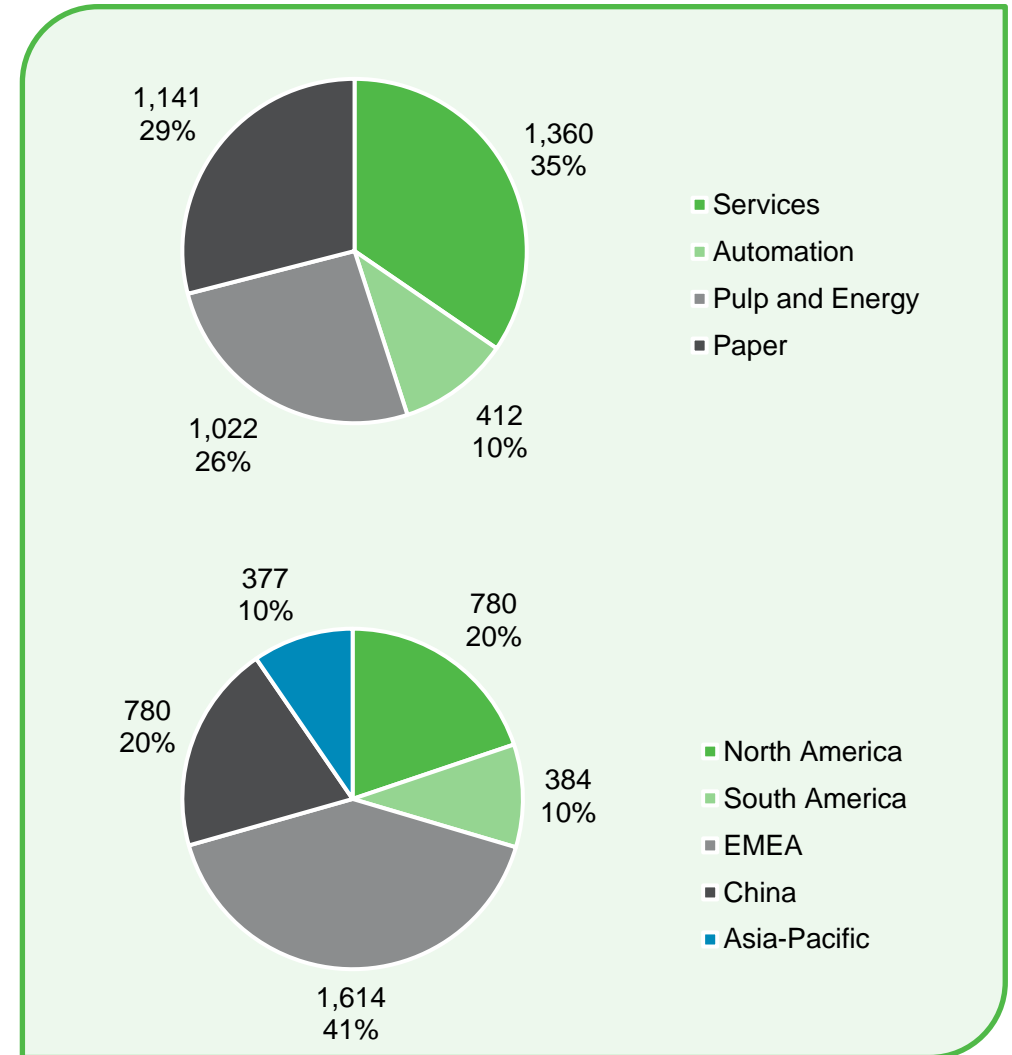

Business line figures restated.

# Business lines in 2021: Stable business

## Services business line

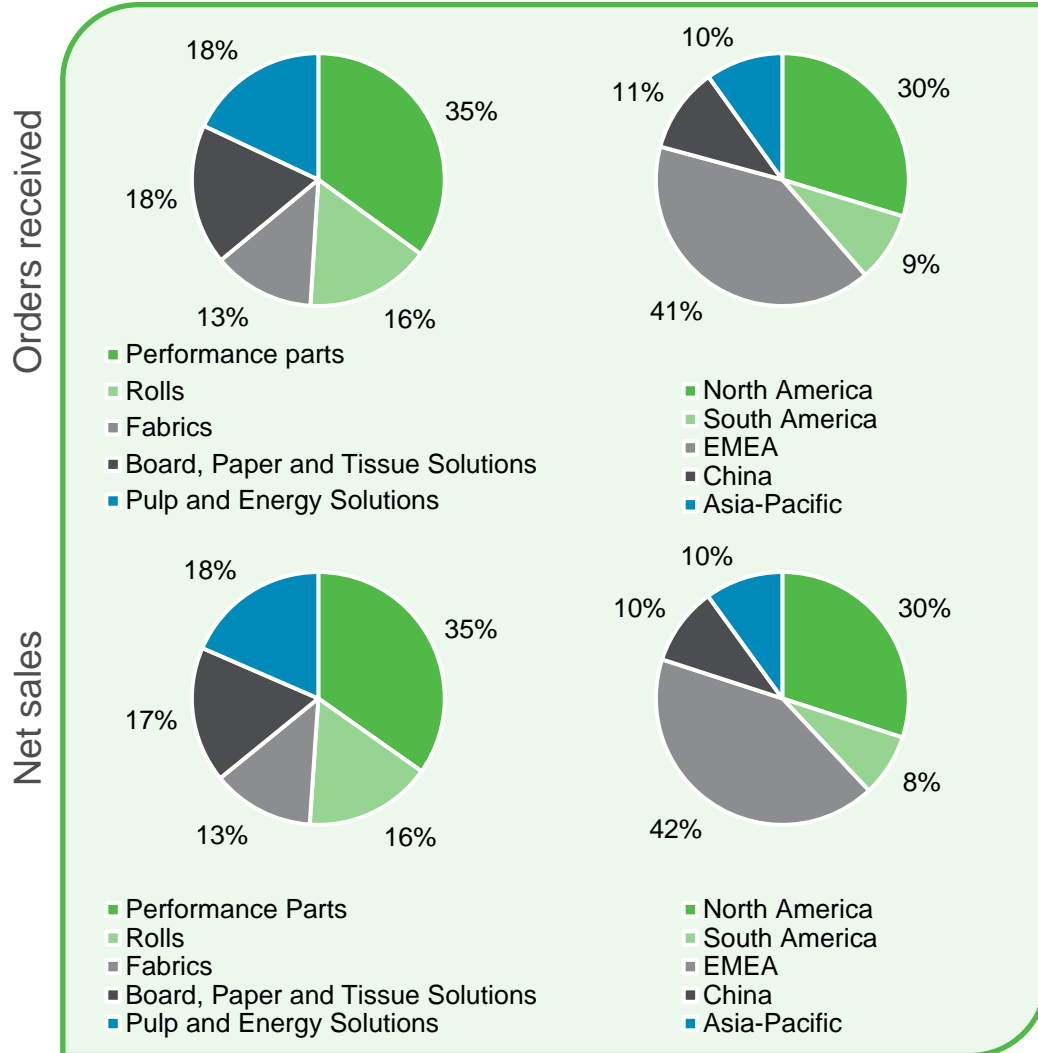

## Automation Systems business line

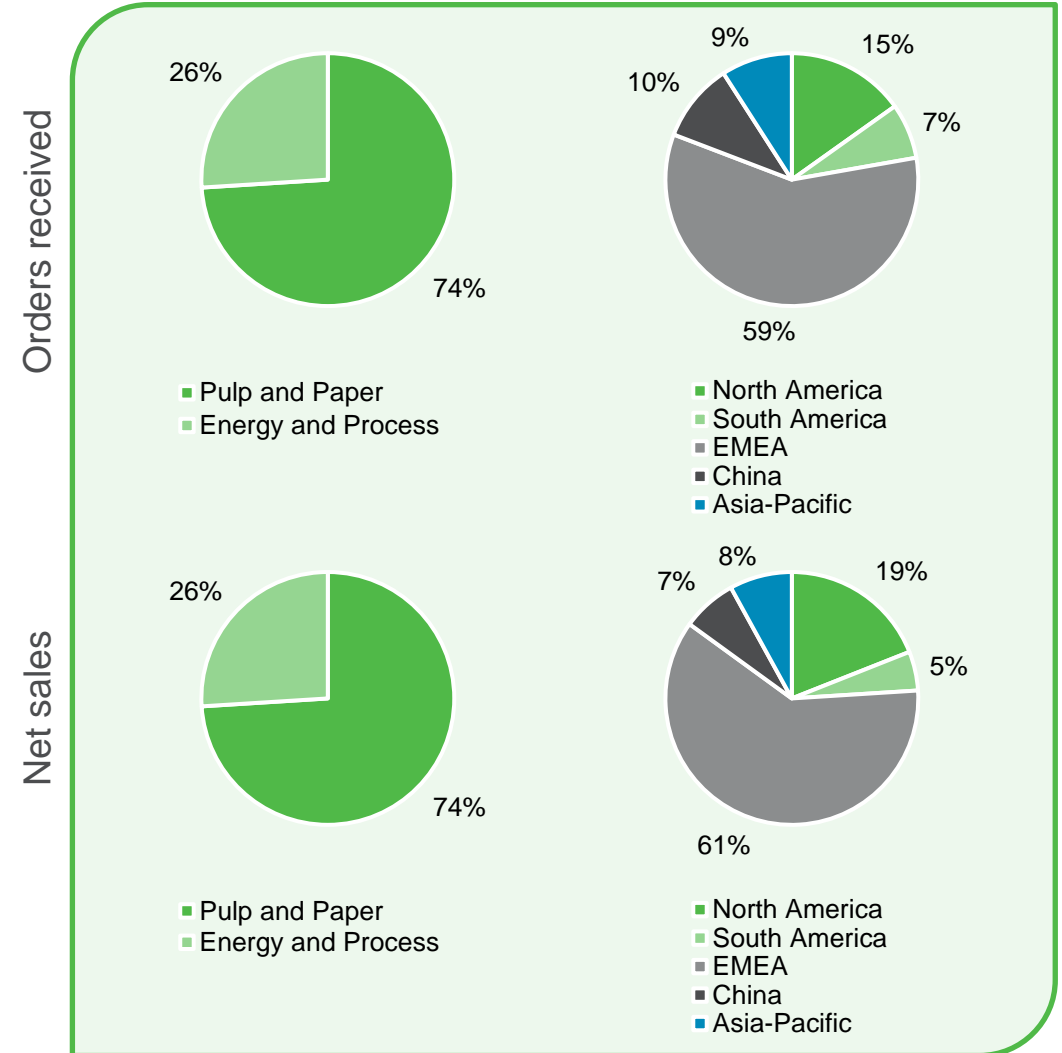

Figures have not been restated.

Split to Pulp and Paper / Energy and Process includes internal orders received and net sales.

# Business lines in 2021: Capital business

## Pulp and Energy business line

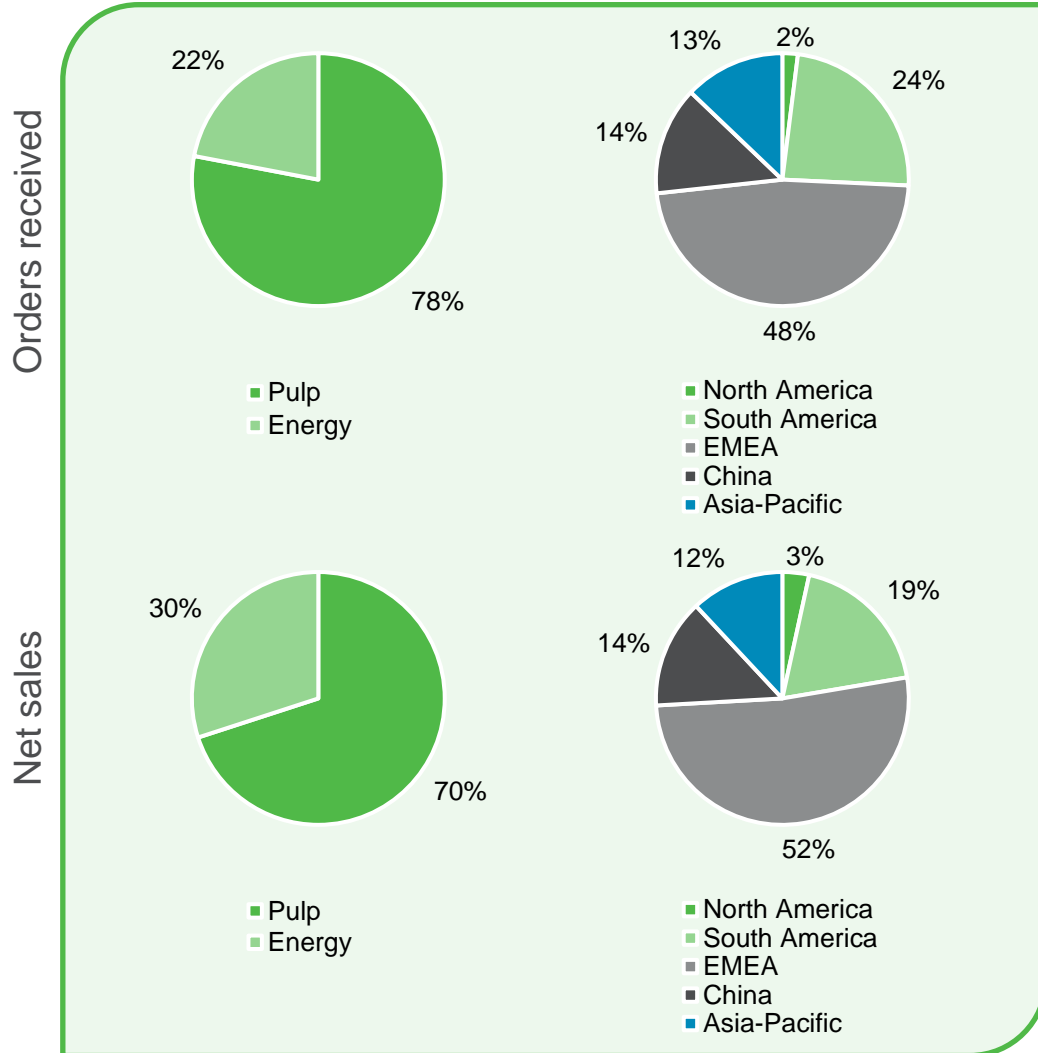

## Paper business line

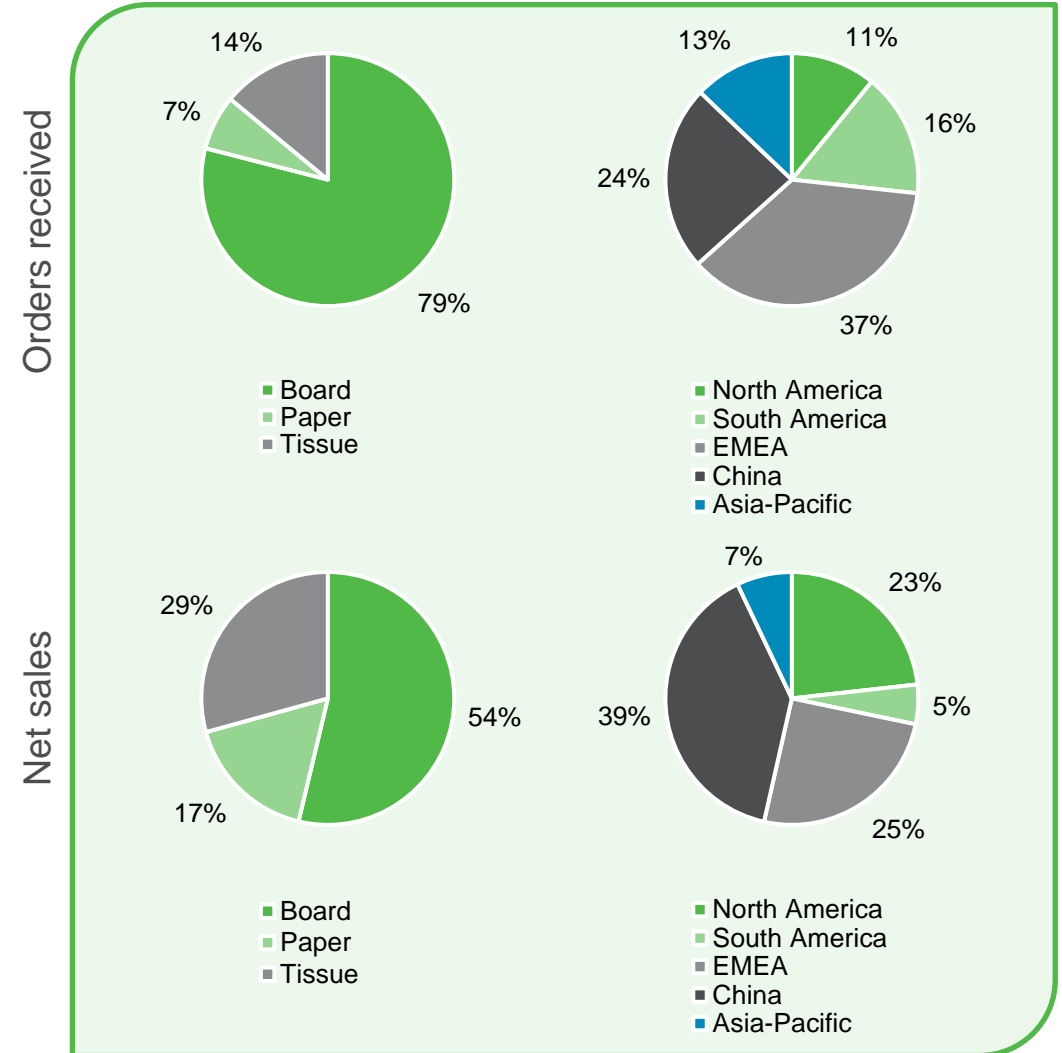

Figures have not been restated.

Figures have not been restated.

# Areas: Orders received and net sales development

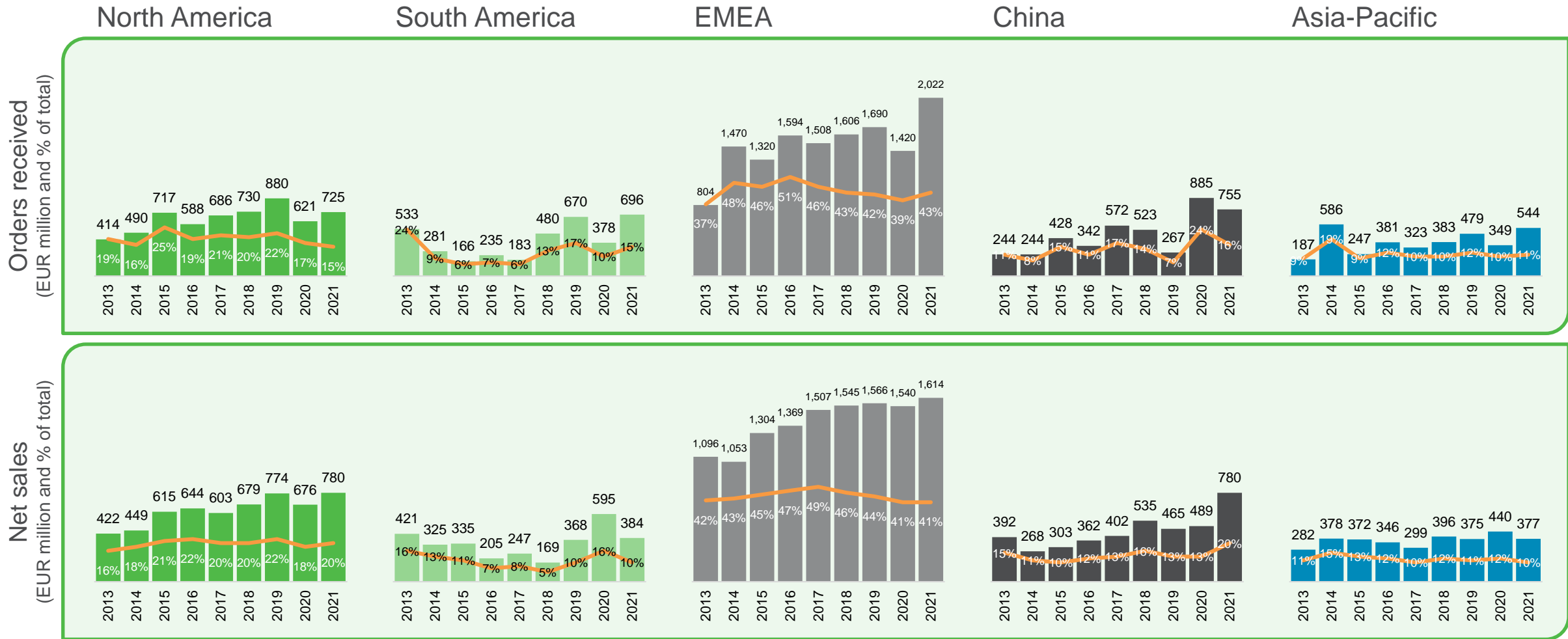

2013 figures on a carve-out basis. Automation business line figures included as of Q2/2015.

# Areas: Business line split in 2021

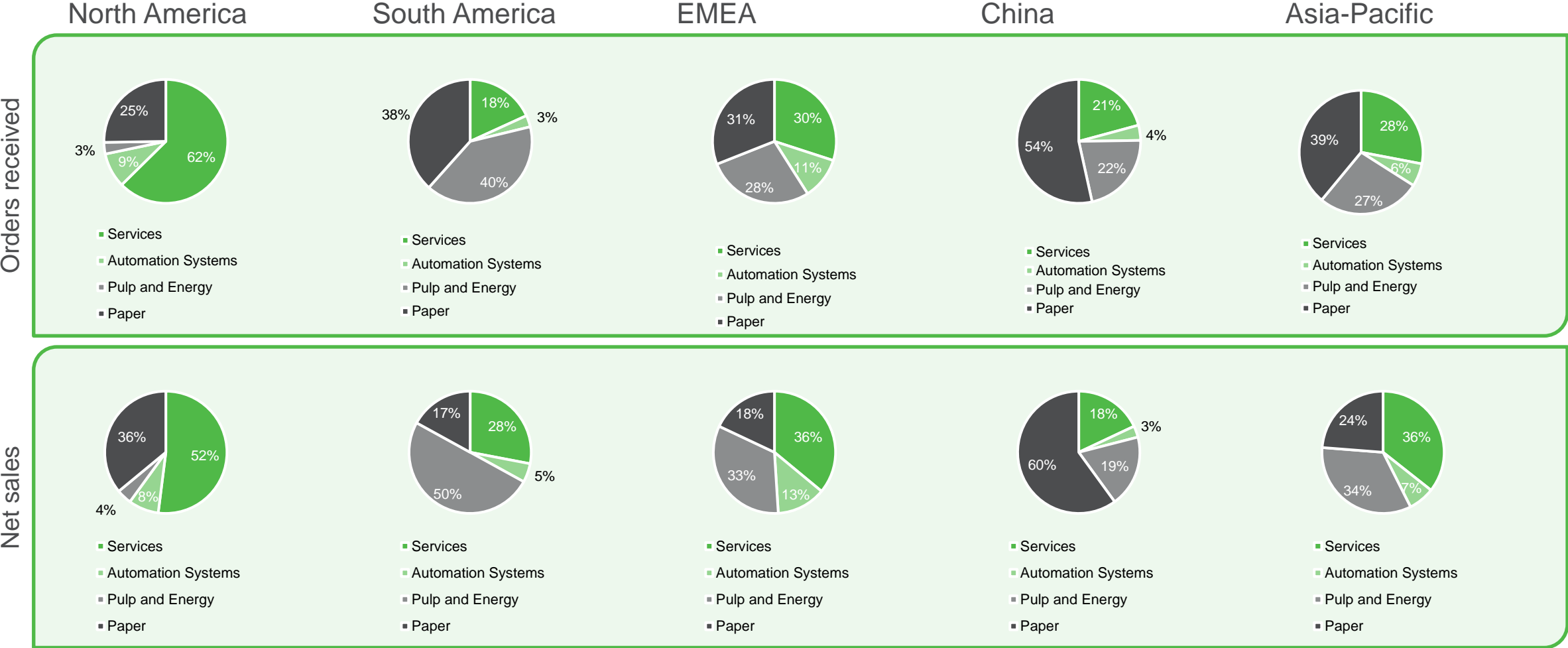

Figures have not been restated.





# Announced orders booked in H1/2022

Booked quarter	Date	Description	Business line	Country	Value
Q1	Feb 2	Waste-to-energy boiler to Thang Long Energy Environment Joint Stock Company	Pulp & Energy	Vietnam	Not disclosed. The value of an order of this type is around EUR 20–30 million.
Q1	Apr 5	Fiberline modernization to CENIBRA	Pulp & Energy	Brazil	Not disclosed. The total value of an order of this type is typically around EUR 25-40 million.
Q1	Apr 13	Sizing section rebuild to Productora Nacional de Papel	Paper	Mexico	Not disclosed. The total value of an order of this type is typically around EUR 15–20 million.
Q1	Apr 28	Fine paper making line to Asia Symbol	Paper	China	Not disclosed. The total value of an order of this type is typically around EUR 80–100 million.
Q1	May 12	BioPower heat and power plant and a pretreatment BioTrac system to ORLEN Poludnie S.A.	Pulp & Energy	Poland	Not disclosed.
Q1	June 28	Two chip washing and defibrator systems to Siempelkamp	Pulp & Energy	Europe and Asia	Not disclosed.
Q2	May 5	OCC, stock preparation and container board lines to Eren Paper	Paper	UK	Not disclosed. The total value of an order of this type is typically around EUR 150–170 million.
Q2	May 11	Completion of biomass boiler, flue gas cleaning and flue gas condensing system works for Vilnius Combined Heat and Power Plant	Pulp & Energy	Lithuania	The total maximum value of the order is around EUR 30 million.
Q2	June 22	Two tissue making lines to Liaoning Yusen Sanitary Products Co., Ltd.	Paper	China	Not disclosed. The total value of an order of this type and delivery scope is typically around EUR 6–8 million.
Q2	July 14	New baling line and flash drying rebuild to MM FollaCell pulp mill in Norway	Pulp & Energy	Norway	The value of this kind of rebuild and scope of supply is typically around EUR 8-10 million.

# Announced orders booked in H2/2021

Booked quarter	Date	Description	Business line	Country	Value
Q3	Jul 7	Turnkey biopower plant for the city of Salzburg	Pulp and Energy	Austria	Not disclosed.
Q3	Sep 17	Container board making line to Kipas Kagit	Paper	Turkey	Not disclosed. The total value of an order of this delivery scope is typically around EUR 90-110 million.
Q3	Sep 23	High-capacity winder to Norske Skog	Paper	France	Not disclosed. The value of an order of this type is typically around EUR 10-20 million.
Q3	Sep 27	Coated board making line	Paper	Asia	Not disclosed. The total value of an order of this delivery scope including the BCTMP order booked in Q2/2021 is typically around EUR 200 million.
Q3	Oct 4	Tissue line to Arkhbum Tissue Group	Paper	Russia	Not disclosed. However, a project of this size and scope is typically valued at around EUR 20-40 million.
Q3	Oct 6	Key board machine technology to Zhejiang Forest United Paper	Paper	China	Not disclosed. However, a project of this size and scope is typically valued at around EUR 10 million.
Q3	Oct 14	OptiConcept M board production line	Paper	USA	Not disclosed. The value of an order of this type is typically around EUR 80-90 million.
Q3	Dec 22	Oxygen delignification system to Arkhangelsk Pulp and Paper	Pulp and Energy	Russia	The value of the order will not be disclosed. However, a delivery with this scope of supply is usually valued between EUR 10-15 million.
Q3	Dec 28	Biomass power boiler and a flue gas cleaning system to Tahara Biomass Power LLC	Pulp and Energy	Japan	The value of the order will not be disclosed. A project of this size and scope is typically valued at around EUR 70 million.
Q4	Nov 5	Major technology and automation delivery for CMPC Guaíba pulp mill's modernization project	Pulp and Energy	Brazil	Not disclosed.
Q4	Dec 9	Long-term Performance Agreement and a board machine rebuild to Metsä Board Husum	Paper	Sweden	The value of the order will not be disclosed. The total value of an order of this type and delivery scope is typically around EUR 70–80 millions.
Q4	Dec 15	Old Corrugated Containers, stock preparation and OptiConcept M container board making lines to Kivanç Tekstil Sanayi Ve Ticaret	Paper	Turkey	The value of the order will not be disclosed. A project of this size and scope is typically valued at around EUR 60–70 million.
Q4	Dec 16	Grade conversion rebuild to VPK's Alizay	Paper	France	Not disclosed.
Q4	Dec 21	Extensive recycled fiber line and paper machine grade conversion rebuild to Model Paper Eilenburg	Paper	Germany	The value of the order will not be disclosed. The total value of an order of this type and delivery scope is typically around EUR 90–100 million.
Q4	Jan 20	Board machine rebuild to Stora Enso	Paper	Sweden	The value of the order will not be disclosed. The total value of an order of this type and delivery scope is typically around EUR 30-40 million.

# Announced orders booked in H1/2021

Booked quarter	Date	Description	Business line	Country	Value
Q1	Jan 15	Extensive tissue machine rebuild for Metsä Tissue	Paper	Finland	Not disclosed
Q1	Jan 29	Textile recycling plant's main equipment for Renewcell	Pulp and Energy	Sweden	Around EUR 25 million
Q1	Feb 19	All main process islands and automation for a bioproduct mill for Metsä Fibre	Pulp and Energy	Finland	About EUR 350-400 million
Q1	Mar 2	A coated board line and a fine paper making line for Fujian Liansheng	Paper	China	Not disclosed. An order of this scope typically adds up to around EUR 190–220 million
Q1	Mar 25	Tissue line for Aktül Kağıt	Paper	Turkey	Not disclosed
Q1	Apr 29	Multifuel boiler plant for Veolia Energie	Pulp and Energy	Czech Republic	Typically, the value of this kind of order is EUR 35-40 million.
Q1	May 11	Two tissue lines for Zhejiang Jingxing	Paper	China	Not disclosed. Typically, the value of this kind of order is around EUR 20-30 million
Q1	May 12	Tissue making line for C&S	Paper	China	Not disclosed. A project of this size and scope is typically valued at around EUR 5-10 million.
Q2	Apr 14	Evaporation plant for Södra Cell	Pulp and Energy	Sweden	Not disclosed. A project of this size and scope is typically valued at around EUR 30 million
Q2	May 17	Drying technology for Spinnova-Suzano joint venture	Paper	Finland	Not disclosed.
Q2	Jun 11	Major pulp and board technology delivery for Klabin	Paper, Pulp and Energy	Brazil	Not disclosed. The total value of order of this type and delivery scope is typically around EUR 320-360 million.
Q2	Jun 23	Two container board making lines for Zhejiang Shanying Paper	Paper	China	Not disclosed.
Q2	Jul 8	Tissue line for Hayat Kimya	Paper	Russia	Not disclosed.
Q2	Jul 13	Conversion from paper machine to fluff pulp drying machine for Daio Paper	Pulp and Energy	Japan	Not disclosed.
Q2	Jul 14	Boiler upgrade and a flue gas cleaning system for Stora Enso	Pulp and Energy	Finland	Typically, the value of this kind of order is EUR 15-20 million.
Q2	Jul 15	Semi-chemical pulp line for Lee & Man Paper	Pulp and Energy	China	Typically, the value of this kind of order is EUR 10-20 million.
Q2	Jul 19	Tissue production line for Eczacıbaşı Consumer Products	Paper	Turkey	Not disclosed.
Q2	Aug 23	Key pulp technology to Nine Dragons	Pulp and Energy	China	Not disclosed. Typically, the value of this kind of order is EUR 140 million.
Q2	Aug 24	Multifuel power boiler and auxiliary process equipment to Kipaş Kağıt	Pulp and Energy	Turkey	Not disclosed. Typically, the value of this kind of order is EUR 25-35 million.
Q2	Aug 30	Paper machine grade conversion rebuild	Paper	Indonesia	Not disclosed. The value of an order of this type is typically around EUR 20-30 million.
Q2	Sep 27	BCTMP production line	Pulp and Energy	Asia	Not disclosed. The total value of an order of this delivery scope including the coated board making line booked in Q3/2021 is typically around EUR 200 million.

# Orders received increased to EUR 1,306 million in Q2/2022

Orders received (EUR million)

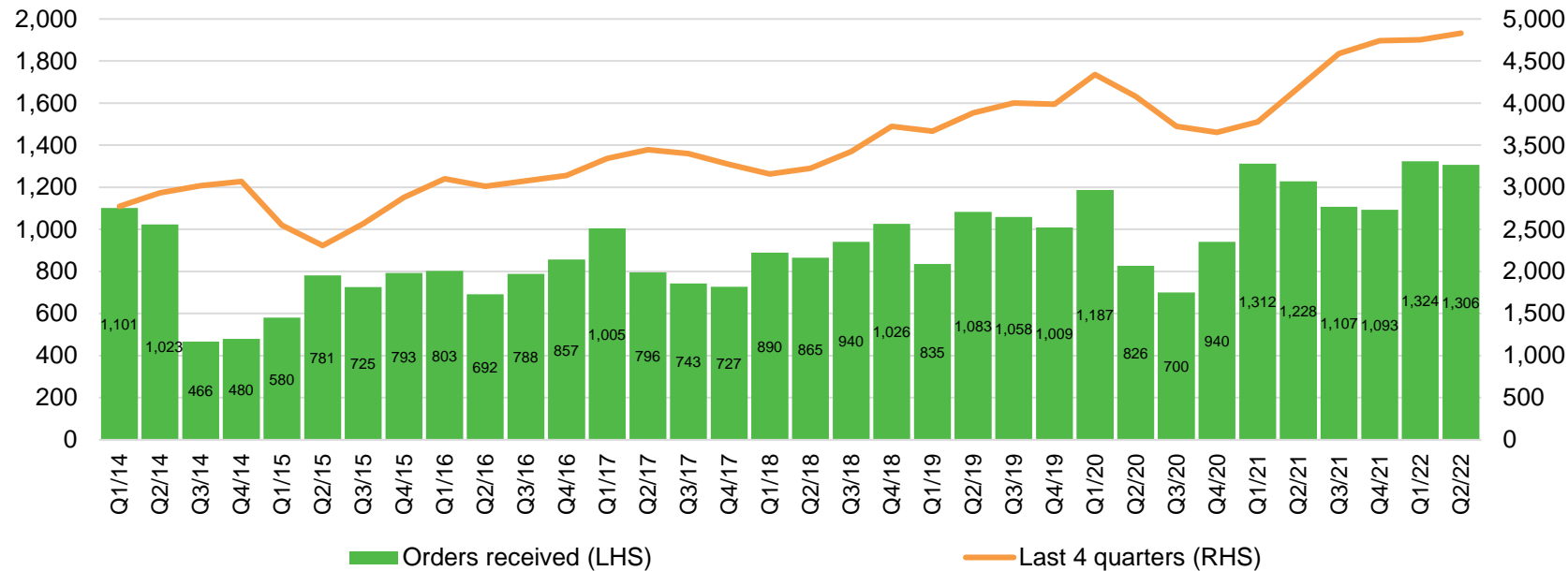

Orders received in H1/2022 by area

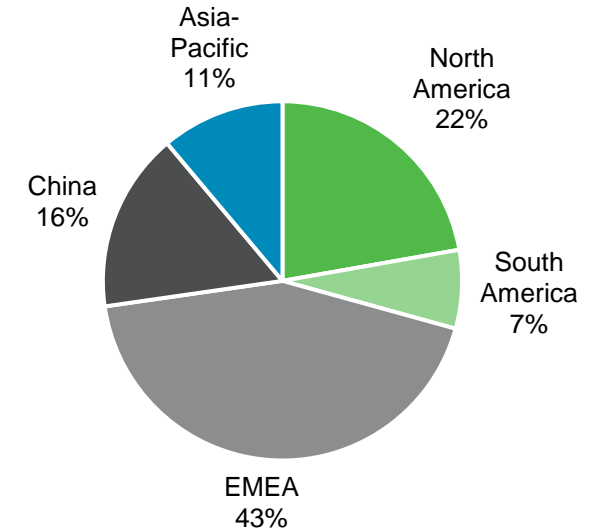

- Orders received increased in North America, Asia-Pacific and EMEA and decreased in South America and China in H1/2022
  - South America, China and Asia-Pacific together accounted for 34% of orders received

# Stable business orders received totaled EUR 2,319 million during the last twelve months

Orders received (EUR million) in stable business

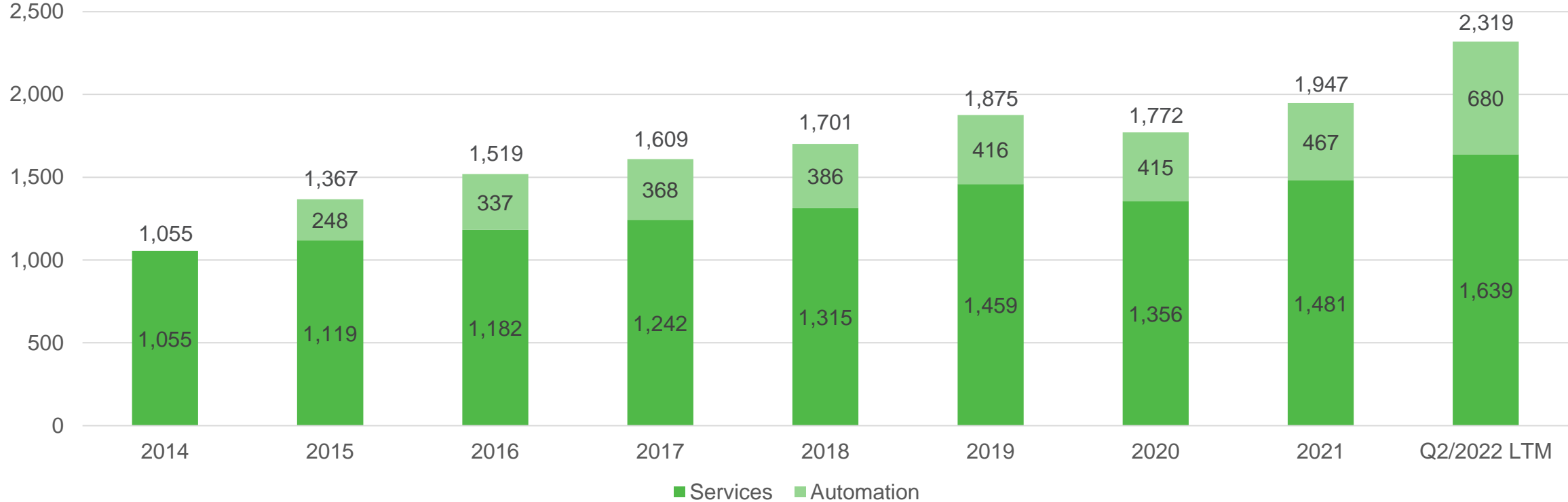

- Total orders received in stable business were EUR 279 million higher in Q2/2022 compared with Q2/2021

2013-2020 figures have not been restated and 2015-2020 figures include internal orders received for the Automation Systems business line.



# Order backlog EUR 4,784 million at the end of Q2/2022

Order backlog (EUR million)

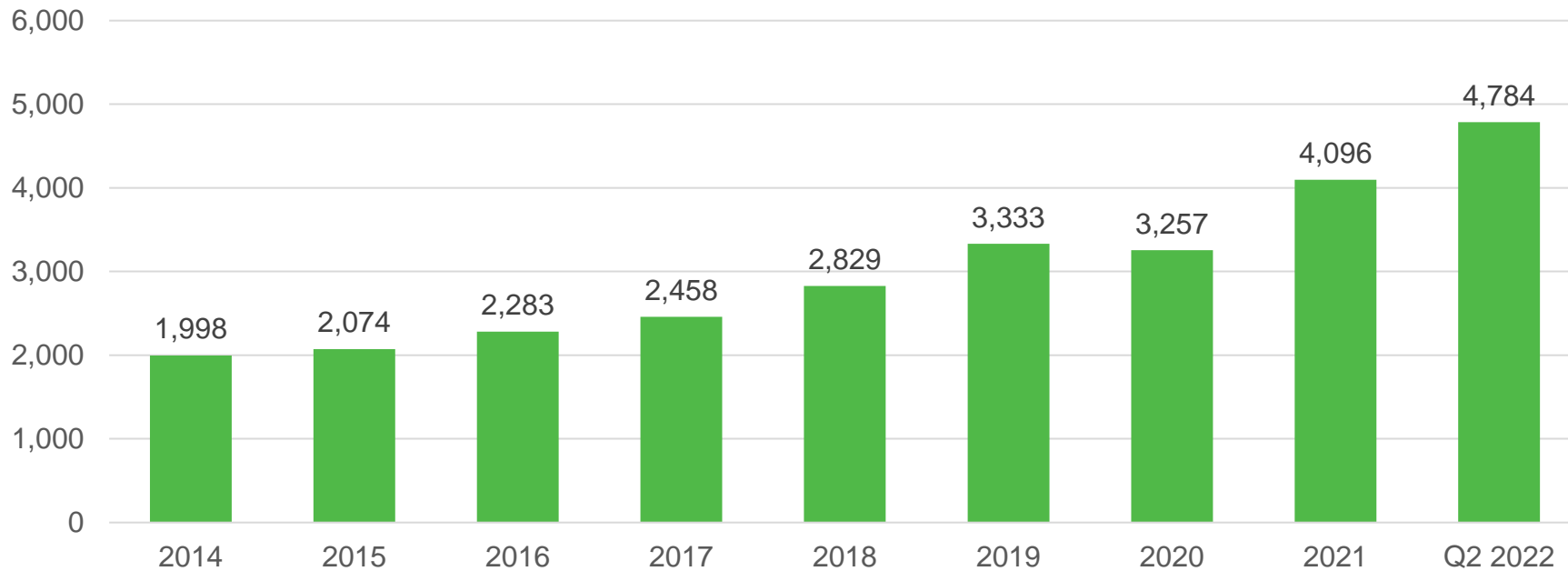

Structure of order backlog by segment

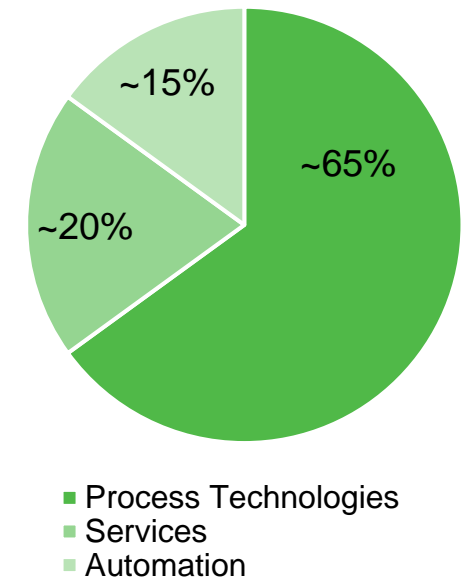

- Order backlog was EUR 688 million higher than at the end of 2021
- Approximately 50% of the order backlog is currently expected to be realized as net sales during 2022 (at the end of Q2/2021, ~45% during 2021)
- Approximately 35% of the order backlog relates to stable business (~25% at the end of Q2/2021)

# Gross profit and SG&A development

Gross profit (EUR million and % of net sales)

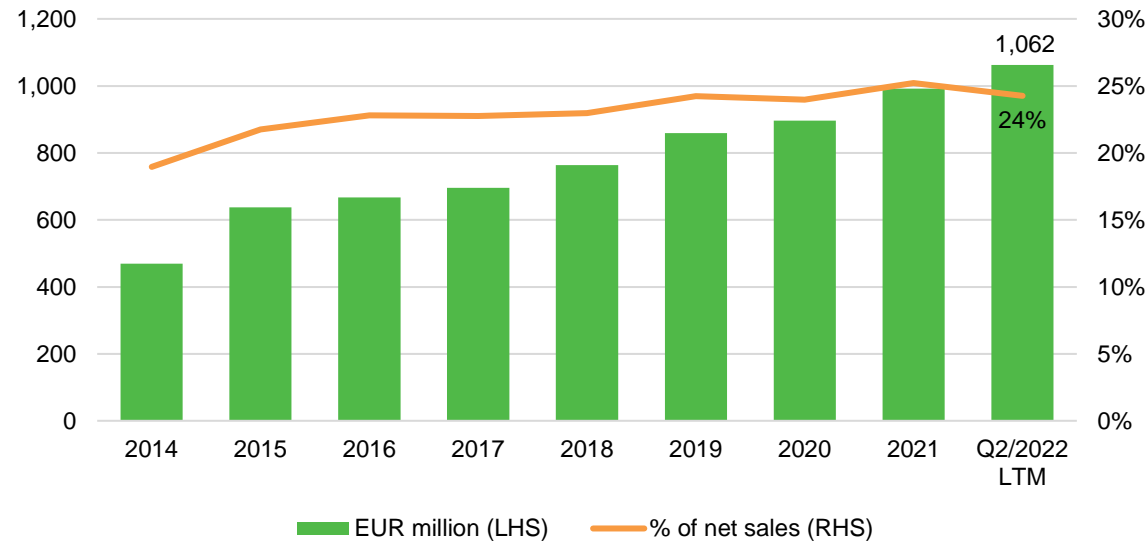

SG&A (EUR million and % of net sales)

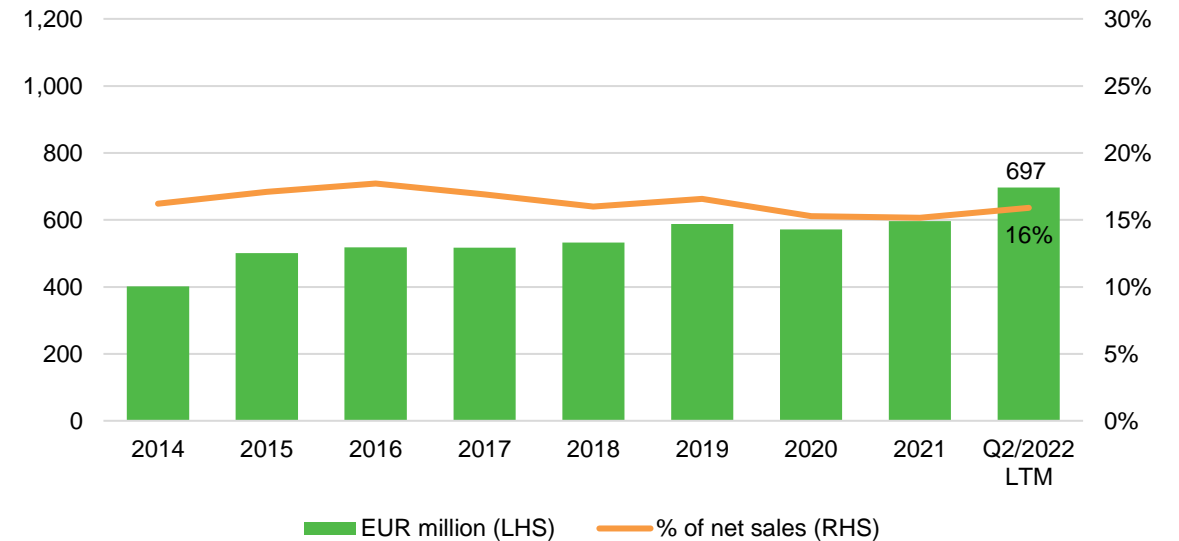

- Gross profit was 24% of net sales in Q2/2022 (26% in Q2/2021)
  - Stable business represented 54% of net sales (46% in Q2/2021)
- Selling, general & administrative (SG&A) expenses were EUR 80 million higher in Q2/2022 compared with Q2/2021
  - SG&A of the Flow Control business line were EUR 55 million in Q2/2022
  - SG&A was 18% of net sales in Q2/2022 (16% in Q2/2021)



# Capital employed, Comparable ROCE and EPS

Capital employed (EUR million) and Comparable return on capital employed (ROCE), before taxes (%)

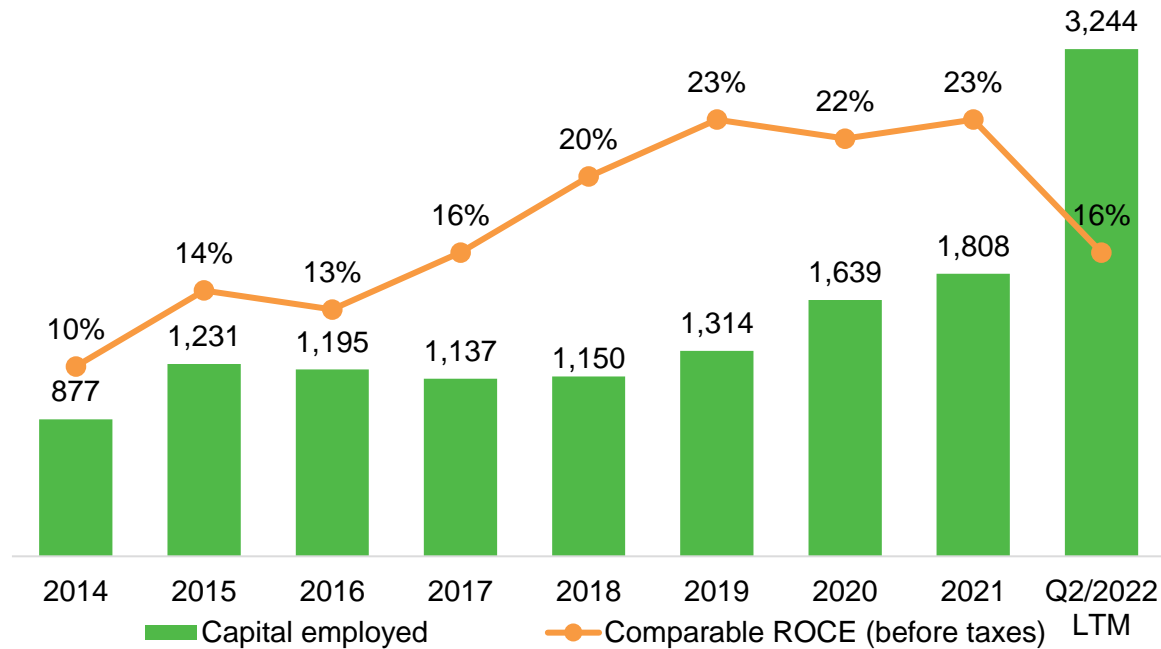

Earnings per share (EPS) and Adjusted EPS, EUR

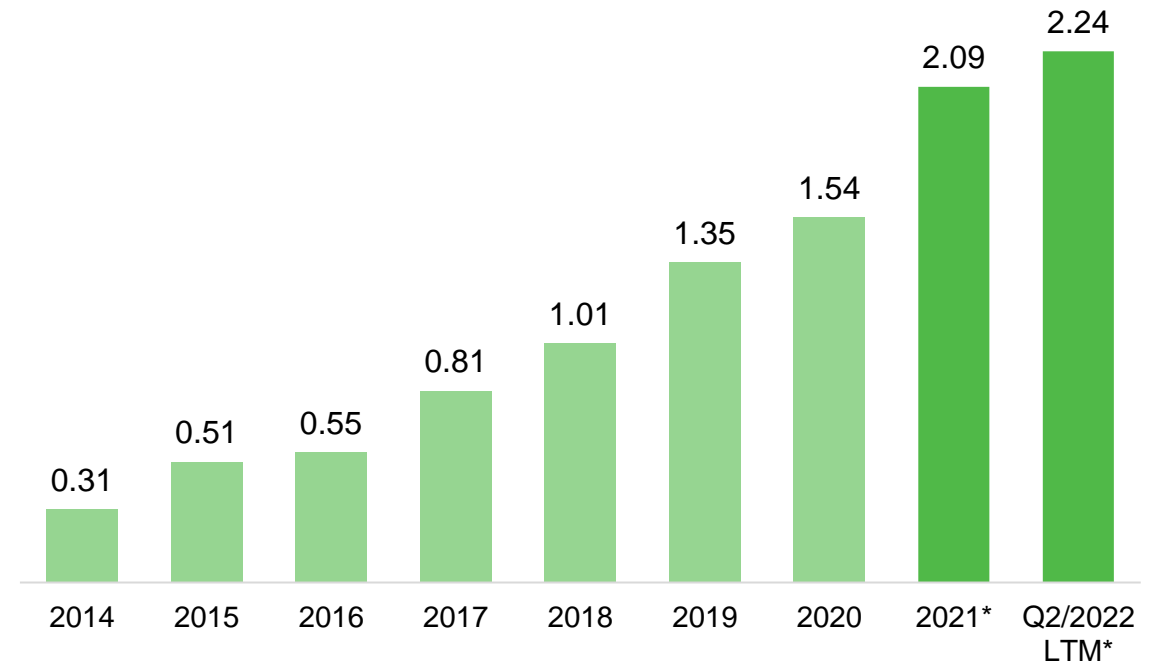

- Comparable ROCE decreased to 16%
- Capital employed was EUR 1,436 million higher than at the end of 2021
- Total merger consideration for Neles amounted to EUR 1,476 million

\*Adjusted EPS. Adjusted earnings per share is a new alternative performance measure that excludes the impact of fair value adjustments arising from business combinations, net of tax

Valmet implemented IFRS 16 – Leases as of January 1, 2019 by applying the simplified transition method, and IFRS 15 – Revenue from Contracts with Customers as of January 1, 2018 by applying full retrospective method. Thus, figures presented are not fully comparable.

# Dividend and balance sheet

## Dividend payout at least 50% of net profit

### Track record

Dividend per share (EUR) and payout ratio (%)

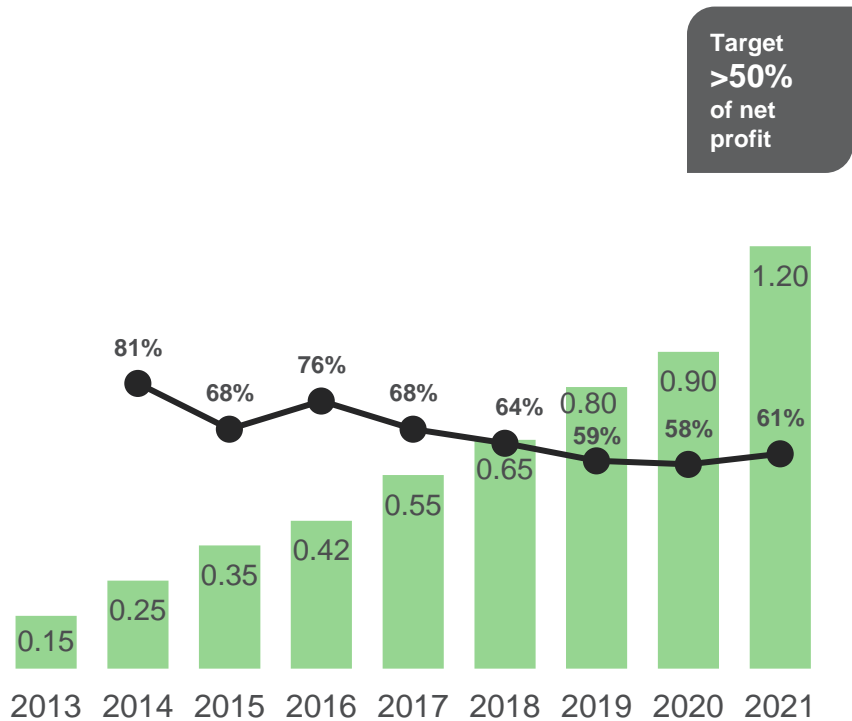

### Balance sheet and cash flow

Net debt (EUR million)  
Net debt / EBITDA ratio

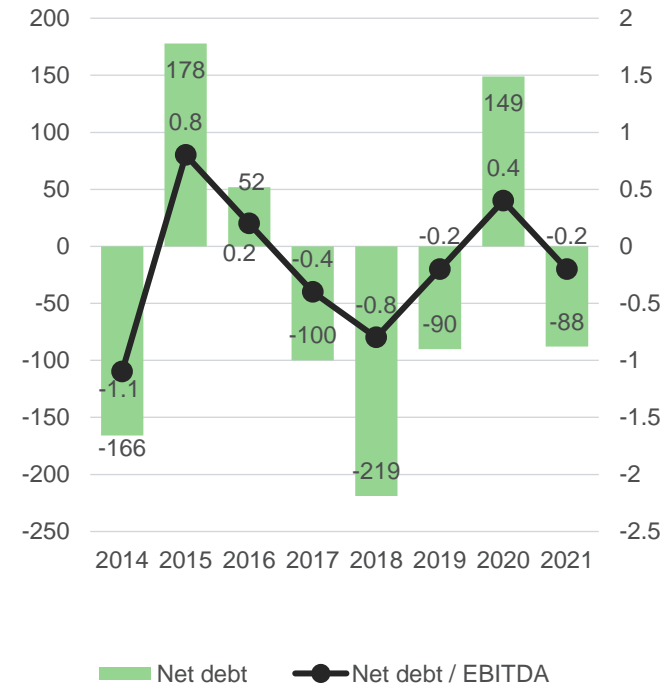

Cash flow provided by operating activities  
Net working capital



# Orders received and profitability development, annual

Orders received (EUR million)<sup>1</sup>

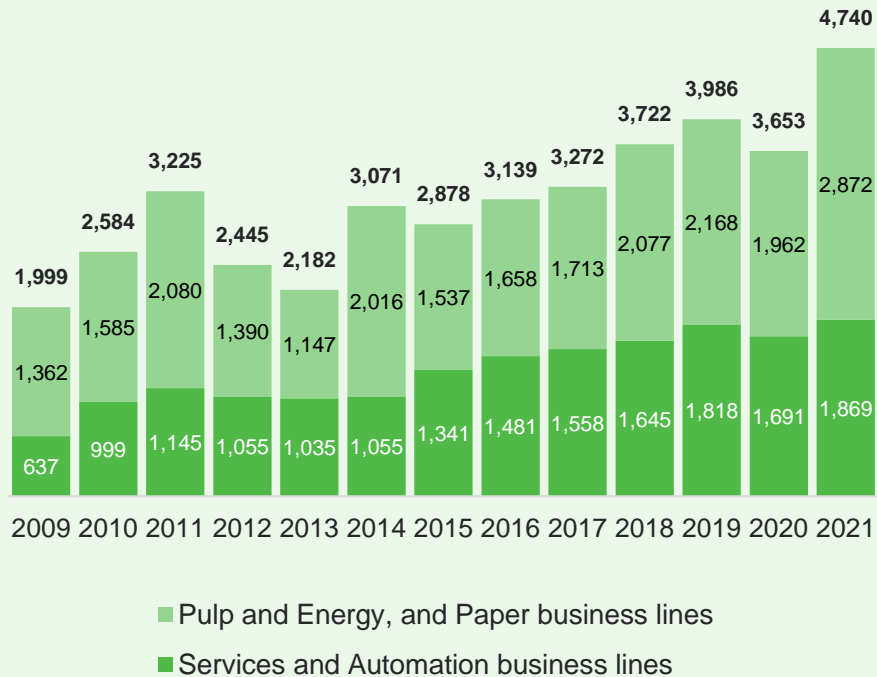

Net sales and Comparable EBITA (EUR million)<sup>1</sup>

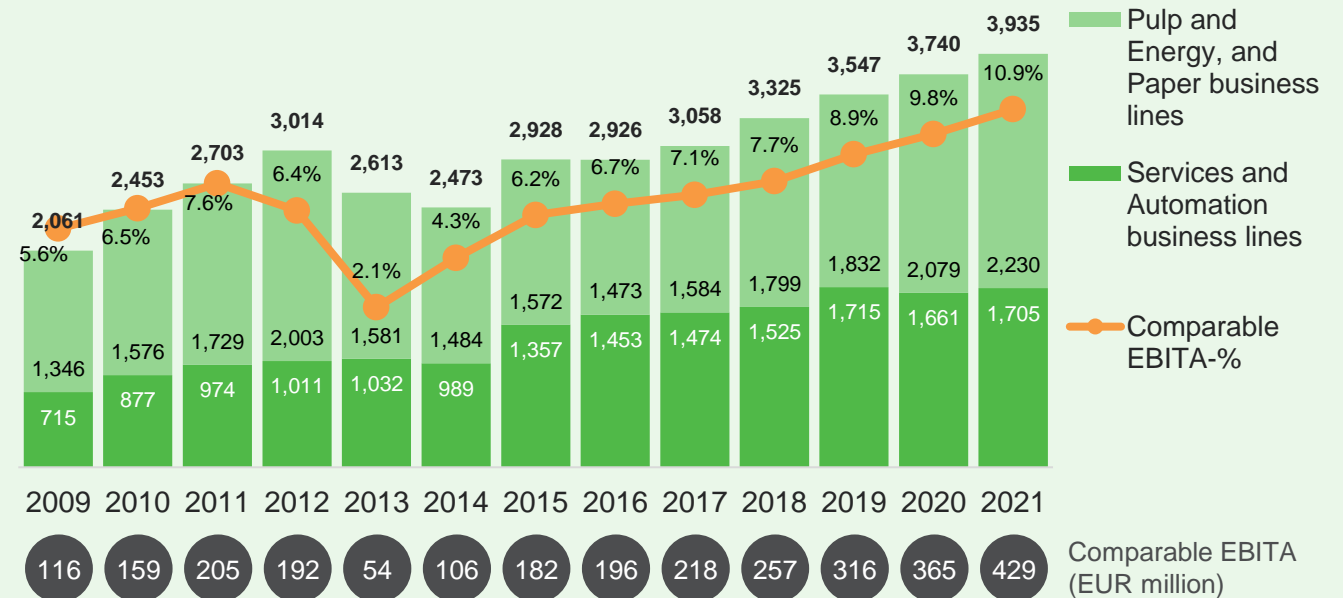

1) Carve-out figures for 2010-2013; as reported for Metso's Pulp, Paper and Power segment for 2006-2009. Automation has been consolidated into Valmet's financials since April 1, 2015, when the acquisition of Automation was completed.



Appendix

# Growth and profitability improvement

# Actions to keep growing faster than the market

## Net sales growth

### Stable business

- Win new customers and increase share of wallet with existing customers
- Grow service sales and multi-year service agreements with project sales
- Add customer value with on-site and remote services
- Continue to develop Field services as a differentiator
- Competitor replacements in Automation Systems
- Grow through new industries in Automation Systems
- Leverage the new Valmet DNA User Interface to win new business in Automation Systems
- Continued growth in existing and new industries such as metals & mining and renewable energy in Flow Control
- Growing both organically and through selected acquisitions in Flow Control

### Capital business

- Benefit from strong favorable megatrends in Board, Tissue, Pulp and Energy
- Continue to bring advanced technology to the market
- Leverage strong R&D for new product innovations
- Continued focus on product cost competitiveness
- Create customer value with digitalization and Industrial Internet

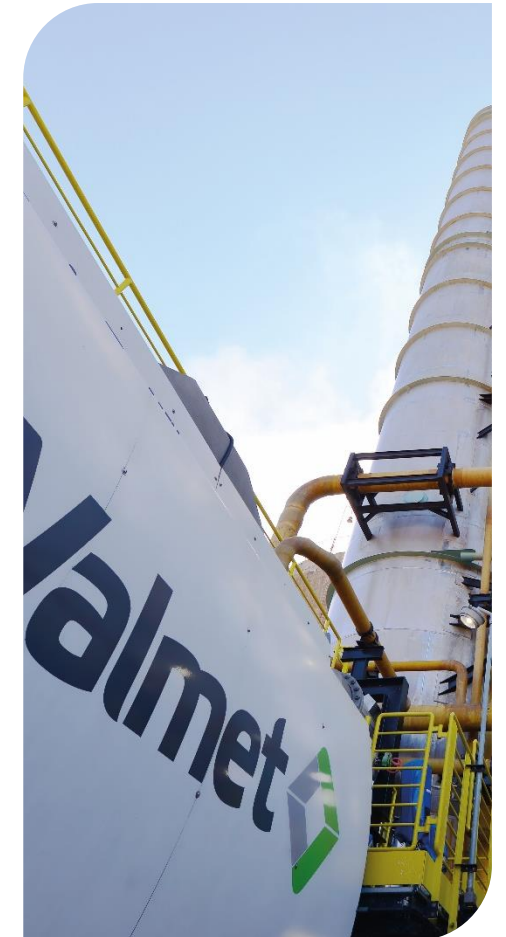

# Procurement and quality cost development

## Implemented procurement savings of annual direct spend

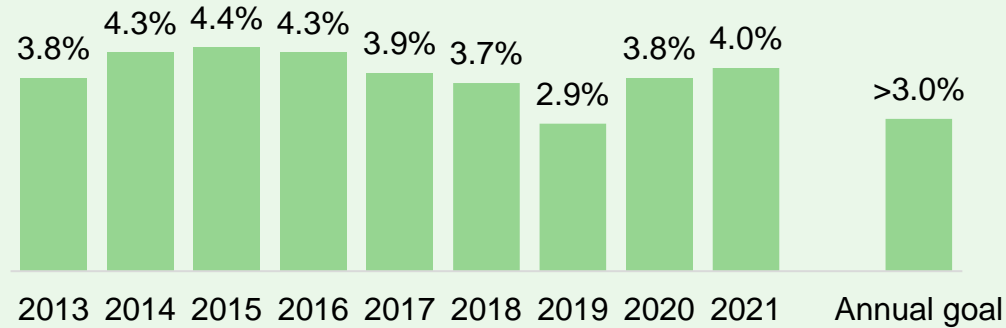

### Targeting >3% of procurement savings annually

- Increasing design-to-cost (DTC) to create new sources for savings
- More supplier involvement through supplier relationship management
- Continuing sustainable supply chain implementation

## Quality costs (% of net sales)

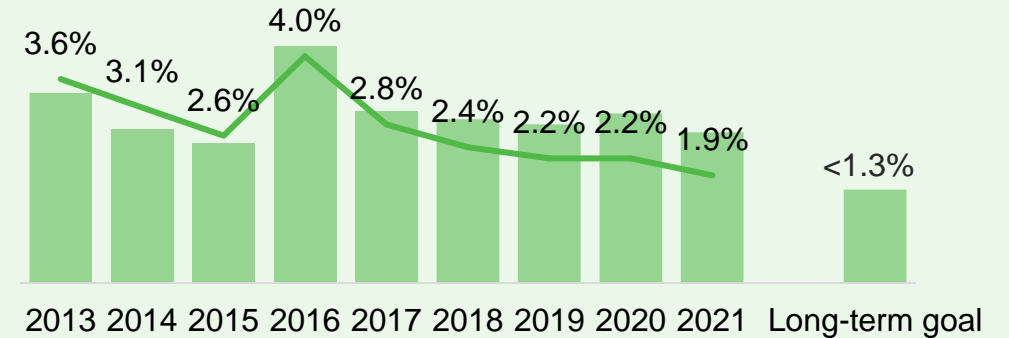

### Long-term quality costs goal <1.3% of net sales

- Adding focus on global processes and Global Management System
- Focused quality development projects related to supplier quality, quality assurance and quality control, continuous improvement, audit and risk management

# Merger of Valmet and Neles created a leading company with a unique offering for process industries globally

- Merger of Valmet and Neles was registered and the combination of Valmet's and Neles' business operations completed on April 1, 2022
- Valmet acquired 29.5% of Neles shares in 2020 for EUR 456 million, average price per share was EUR 10.27
- Merger consideration to Neles' shareholders was approximately 34.7 million Valmet shares, amounting to EUR 978 million
- The total cost of Neles' shares acquired by Valmet amounted to EUR 1,434 million
- Valmet's share price at the end of March 31, 2022, was EUR 28.21
- Valmet's number of shares increased to approximately 184.5 million
- Neles' extra distribution before the merger to Neles shareholders was EUR 2.00 per share
- Starting from Q2/2022, Neles is part of Valmet's Automation segment and forms the fifth business line to Valmet, called Flow Control

# Acquisitions

- Valmet's acquisition strategy is to make selective acquisitions with a clear industrial logic to support organic growth
  - Focus on strengthening services and automation and expanding business in the pulp, paper and energy value chain
- Approximately 50 cases evaluated annually
- Eight acquisitions made since becoming independent company in 2014
- Total investment in acquisitions and in the merger with Neles about EUR 2 billion

## Track record of successful acquisitions

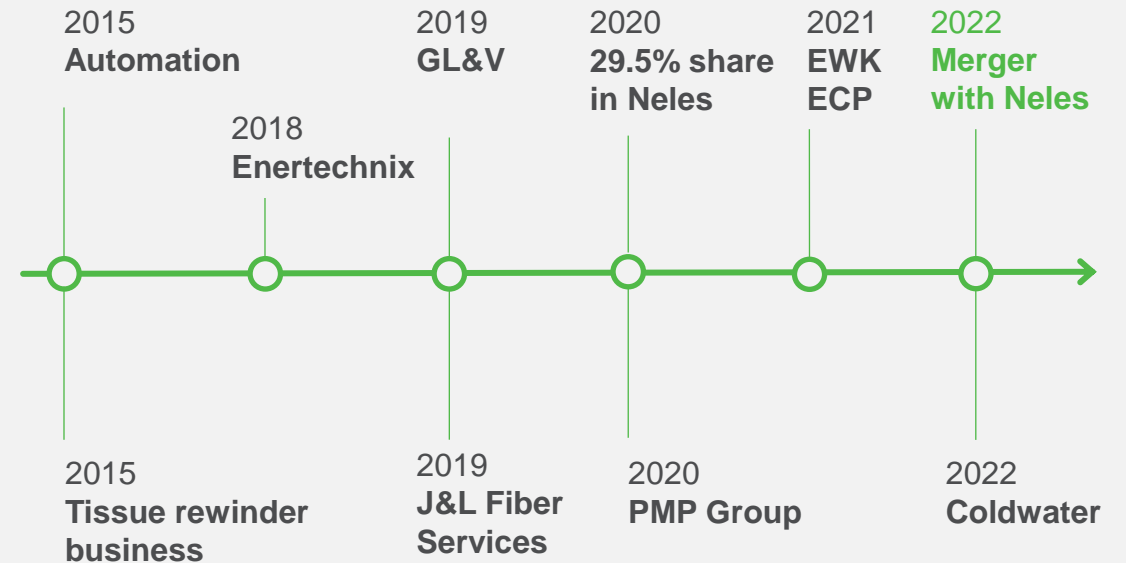



# Valmet strengthened its business by acquiring PMP Group in 2020

Focus on small and medium-sized tissue machines and board and paper machine rebuilds

- PMP Group supplies process technologies and services for tissue, board and paper machines globally
  - New tissue machines
  - Rebuilds and machine sections for paper and board machines
  - Spare parts and services
- Focus on small and medium-sized tissue machines and board and paper machine rebuilds
- The acquisition complements Valmet's offering and builds further our local presence especially in Central Europe and China
  - Widens Valmet's portfolio to small and medium-sized tissue machines
  - Access to new customer and product segments
- Operations in four countries: Poland, China, USA and Italy
- The acquisition was announced on September 11, 2020 and was completed on October 1, 2020

## Key information about the acquisition

Net sales in 2019	EUR ~70 million
Number of employees	~650
Value of acquisition	EUR ~64 million <sup>1</sup>

1) Plus a conditional and capped earn-out component.

## Operations in Poland, China, USA and Italy



# Valmet strengthened its stable business through acquisitions

Valmet completed the acquisitions of GL&V and J&L Fiber Services in Q2/2019

- **GL&V** is a supplier of technologies, upgrade and process optimization services, rebuilds and spare parts for the pulp and paper industry globally
  - Focus in chemical pulping, stock preparation, papermaking and finishing
  - Key locations in the US and Canada, operations also in Europe, India and South America
- Majority of the business is reported in the Services business line

- **J&L Fiber Services** is a manufacturer and provider of refiner segments to the pulp, paper and fiberboard industry
  - Most of the employees are located in Wisconsin, U.S, with global operations through a sales representative and distribution network.
- The acquired business became a part of Valmet's Services business line

## Key information

Net sales in 2018	EUR ~160 million
EBITA margin in 2018	~11%
Number of employees	~630
Value of acquisition <sup>1</sup>	EUR ~113 million

<sup>1</sup>) Value on a cash and debt free basis subject to ordinary post-closing adjustments

## Approximate split of net sales

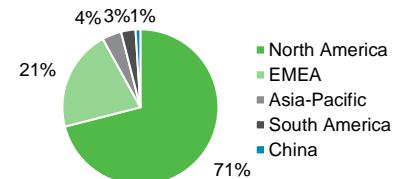



## Key information

Net sales in 2018	EUR ~30 million
EBITA margin in 2018	~15%
Number of employees	~100
Value of acquisition <sup>1</sup>	EUR ~51 million

<sup>1</sup>) Value on a cash and debt free basis subject to ordinary post-closing adjustments

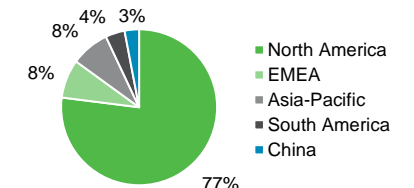
## Approximate split of net sales





Appendix  
**Shareholders and share price  
development**

# Largest shareholders on August 31, 2022

Based on indicative data collected by Modular Finance

#	Shareholder name	Number of shares	% of shares and votes
1	Solidium Oy	18,640,665	10.10 %
2	Oras Invest Oy	7,947,691	4.31 %
3	Ilmarinen Mutual Pension Insurance Company	5,992,993	3.25 %
4	Swedbank Robur Fonder	5,922,858	3.21 %
5	Vanguard	5,416,429	2.94 %
6	Varma Mutual Pension Insurance Company	4,686,789	2.54 %
7	BlackRock	4,602,843	2.49 %
8	Cevian Capital	4,408,171	2.39 %
9	Handelsbanken Fonder	3,265,451	1.77 %
10	Norges Bank	3,032,001	1.64%
	<i>10 largest shareholders, total</i>	63,915,891	34.64 %
	Other shareholders	120,613,714	65.36 %
	<b>Total</b>	<b>184,529,605</b>	<b>100.0%</b>

## Five latest flagging notifications

Date of transaction	Shareholder	Number of shares	% of shares and votes
Aug 28, 2019	BlackRock, Inc.	Below 5%	Below 5%
Aug 29, 2019	BlackRock, Inc.	7,740,836	5.16%
Aug 30, 2019	BlackRock, Inc.	Below 5%	Below 5%
Apr 1, 2022	Solidium Oy	17,072,199	9.25%
May 19, 2022	Solidium Oy	18,640,665	10.10%

1) Solidium is a holding company that is wholly owned by the Finnish State



# Shareholder structure on August 31, 2022

Based on Euroclear data. The classification of sectors determined by Statistics Finland.

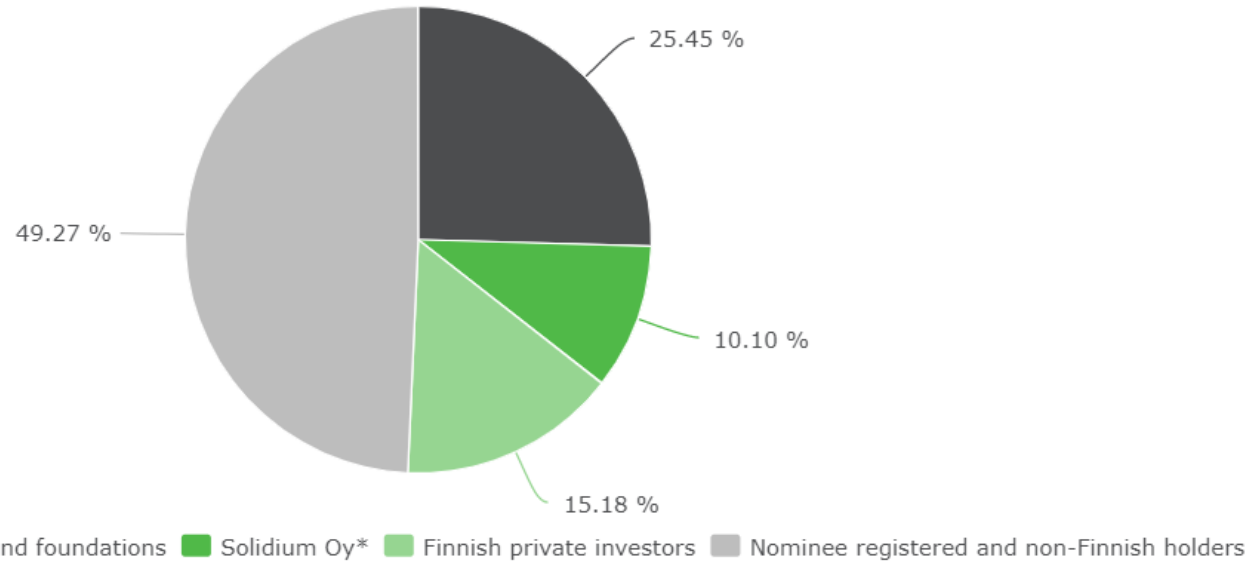

Sector	Number of shareholders	% of total shareholders	Number of shares	% of shares
Nominee registered and non-Finnish holders	475	0.57	90,917,430	49.27
Finnish institutions, companies and foundations	4,048	4.86	46,957,651	25.45
Solidium Oy*	0	0.00	18,640,665	10.10
Finnish private investors	78,797	94.57	28,003,264	15.18
On issuer account	0	0.00	10,595	0.01
<b>Total</b>	<b>83,320</b>	<b>100.00</b>	<b>184,529,605</b>	<b>100.00</b>

\* Solidium is a holding company that is wholly owned by the Finnish State

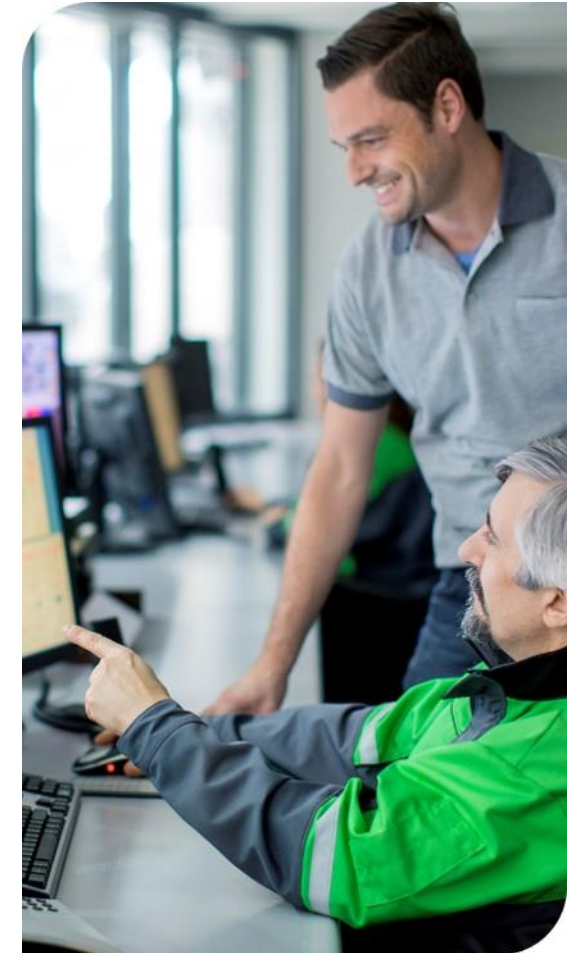

# Share of non-Finnish holders and number of shareholders

Valmet has 83,320 shareholders and 49.29% of the shares are held by investors outside Finland

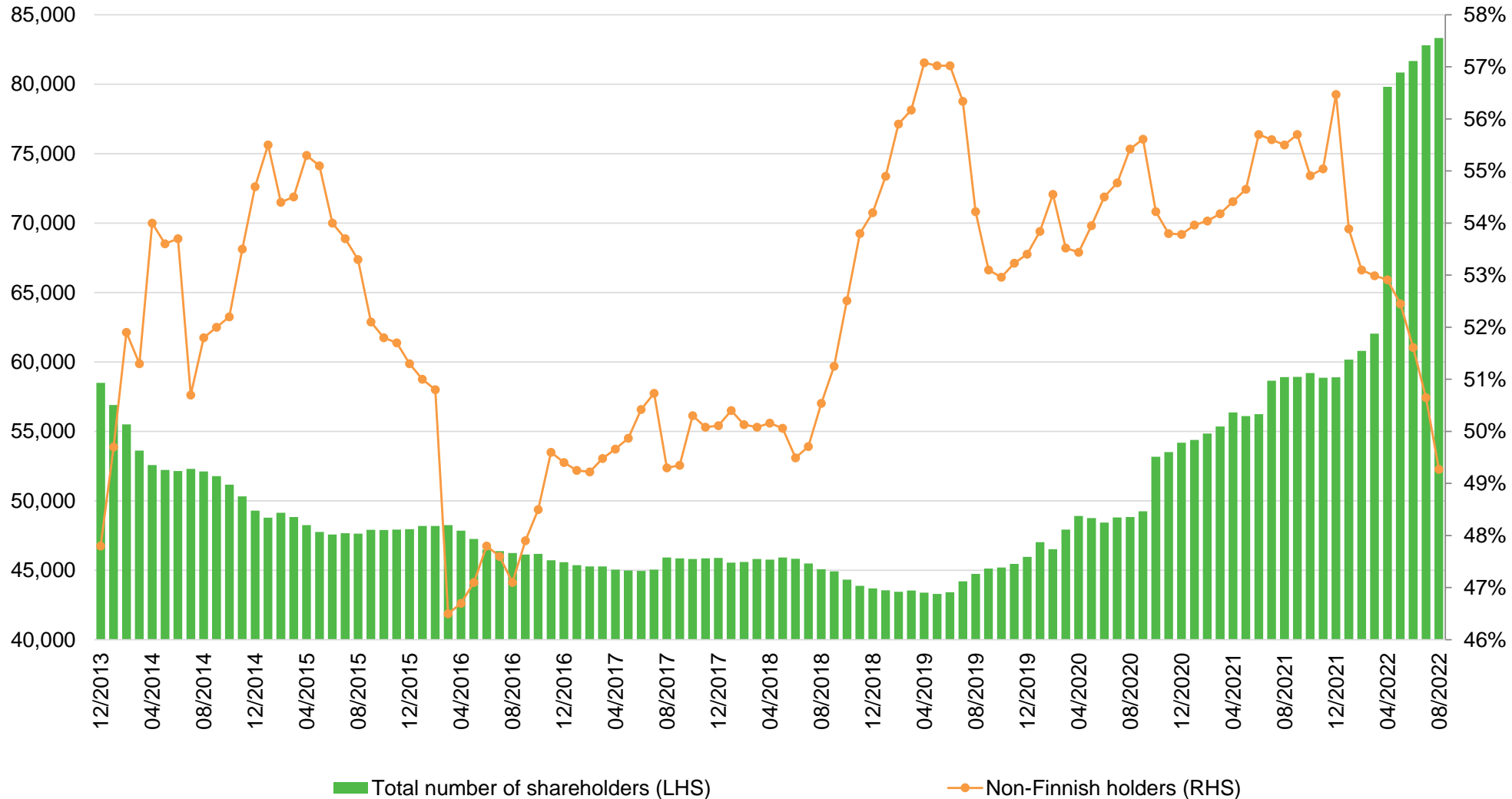

# Valmet share price development

Valmet share price development vs OMXH price index, last 3 years



Share price	Valmet	OMX Helsinki
<b>December 31, 2021</b>	37.72	12,862
<b>August 31, 2022</b>	25.30	10,679
<b>High</b>	38.41	13,132
<b>Low</b>	22.79	9,975
<b>Market cap (EUR million)</b>	4,669	

	Volume 2022	% of outstanding
<b>Total</b>	90,683,339	49.1%
<b>Median</b>	477,026	0.3%
<b>Average</b>	539,782	0.3%
<b>Max</b>	4,062,755	2.2%
<b>Min</b>	179,018	0.1%
<b>Total no. of shares</b>	184,529,605	

Source: Infront

Note: % of outstanding figures not adjusted for the changed number of shares after the merger.



Appendix  
**Strategy and offering**



# Valmet's Way Forward

## Mission

Converting renewable resources into sustainable results

## Strategy

Valmet develops and supplies competitive and reliable process technologies, services and automation to the pulp, paper and energy industries.

Our automation business covers a wide base of global process industries.

We are committed to moving our customers' performance forward with our unique offering and way to serve.

## Continuous improvement and renewal

### Must-Wins

- Customer excellence
- Leader in technology and innovation
- Excellence in processes
- Winning team

### Business accelerators

## Vision

To become the global champion in serving our customers and in moving the industries forward

## Our Values



### Customers

We move our customers' performance forward



### Renewal

We promote new ideas to create the future



### Excellence

We improve every day to deliver results



### People

We work together to make a difference

## Megatrends

- Resource efficient and clean world
- Digitalization and new technologies
- Urban, responsible and global consumer

# Services segment



## Performance Parts

Spare parts and consumables



## Rolls and Workshop Services

Rolls, roll covers and maintenance, workshop services



## Fabrics

Paper machine clothing and filter fabrics



## Board, Paper and Tissue Solutions

Improvement Projects, Field Services, Life Cycle Agreements, Outsourcing

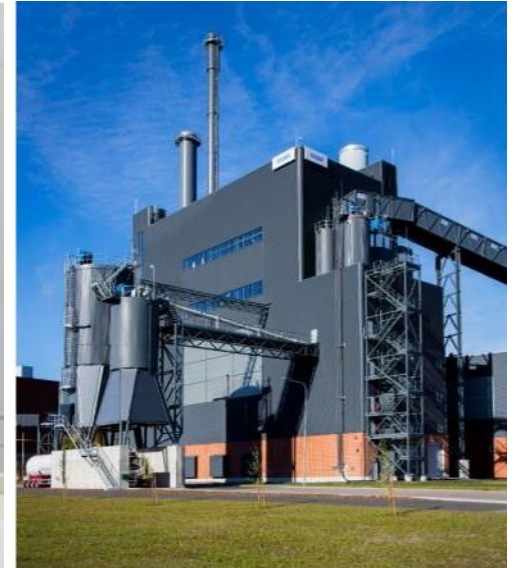

## Pulp and Energy Solutions

Improvement Projects, Field Services, Life Cycle Agreements, Outsourcing

# Our way to serve - Right combination of services for every stage in the lifecycle

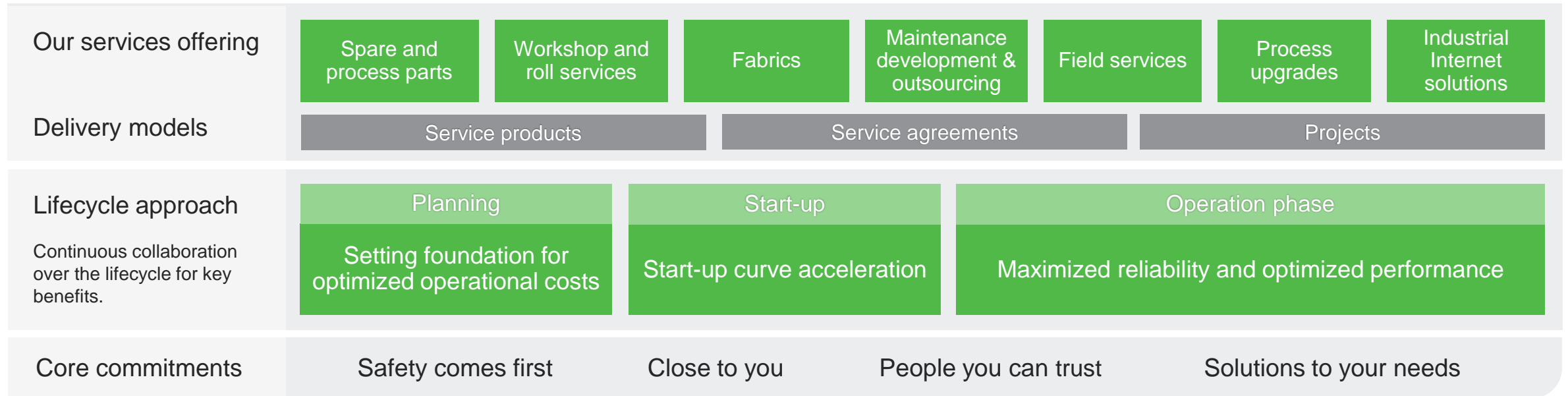



# Flow Control business line offering



- Control valves
- Automated on/off valves
- Emergency shut-down valves



High-performing pneumatic, electric and manual actuators designed to maximize cycle life and improve process efficiency



Automatic valve controllers and valve positioners to improve process efficiency and enable predictive valve maintenance

# Automation Systems business line offering

Delivered as products and technology, projects and service agreements



- Highly integrated automation system for process control and condition monitoring.



- Quality control system, quality management applications.



- For measuring and optimizing different variables in industrial processes.



- Advanced controls and data-driven applications for assisted decision making and mill-wide optimization.
- Remote expert support from Valmet Performance Center.
- Valmet Customer portal for relevant information and collaboration.



- Services for high availability, intelligent maintenance, process performance and risk control.

# Future-proof automation solutions and services

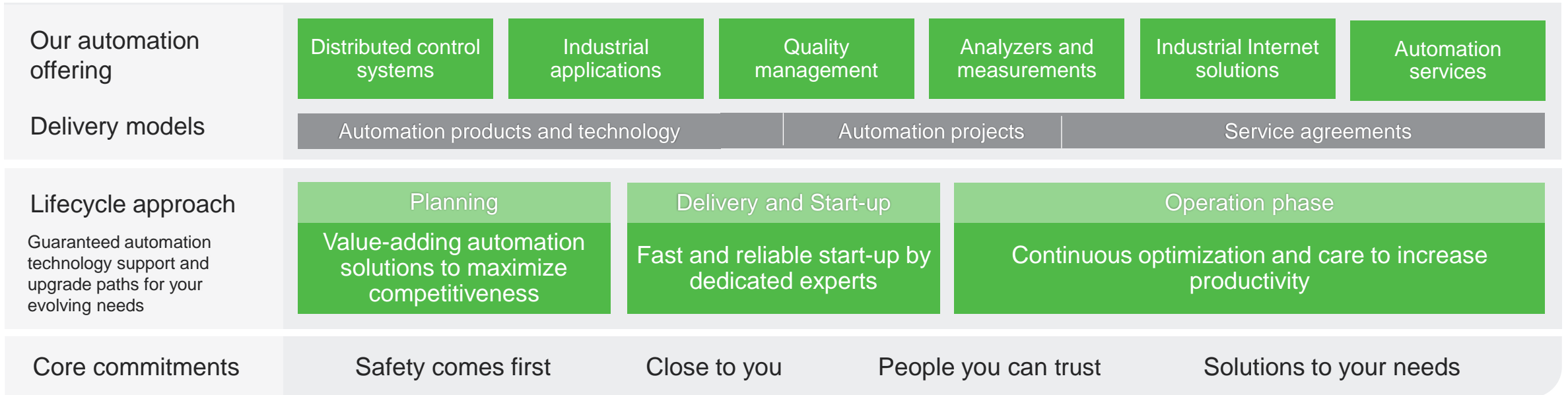





# Automation Systems business line offering and market overview

## Advanced automation and process monitoring solutions and services:

- Distributed Control System (DCS) – Valmet DNA
- Performance solutions
- Quality Control System (QCS)
- Profilers
- Analyzers and measurements
- Industrial internet solutions
- Automation services
- Process simulators
- Safety systems and solutions

Over 4,500 automation systems and over 40,000 analyzers and measurements delivered

	Scope/product	Market size	Main competitors
<b>Distributed Control System (DCS)</b>  #3	<ul style="list-style-type: none"> <li>• DCS for process and plant controls</li> <li>• Condition monitoring</li> <li>• Information management</li> <li>• APC (advanced process control)</li> <li>• Industrial Internet applications</li> </ul>	Pulp and paper DCS market: <ul style="list-style-type: none"> <li>• EUR 900 million</li> </ul> Power DCS market: <ul style="list-style-type: none"> <li>• EUR 700 million</li> </ul>	<ul style="list-style-type: none"> <li>• ABB</li> <li>• Honeywell</li> <li>• Emerson</li> <li>• Siemens</li> <li>• Yokogawa</li> </ul>
<b>Quality Management System</b>  #1-2	<ul style="list-style-type: none"> <li>• QCS (Quality Control Systems)</li> <li>• Profilers</li> <li>• Web inspection and web break analysis systems</li> </ul>	Estimated market size: <ul style="list-style-type: none"> <li>• &gt;EUR 200 million</li> </ul>	<ul style="list-style-type: none"> <li>• ABB</li> <li>• Honeywell</li> <li>• Voith</li> <li>• Paperchine</li> <li>• Procemex</li> <li>• Cognex</li> <li>• Isra Vision</li> </ul>
<b>Analyzers and measurements</b>  #1	<ul style="list-style-type: none"> <li>• Paper analyzers</li> <li>• Pulp analyzers</li> <li>• Pulp consistency measurements</li> <li>• Conductivity measurements</li> <li>• Power analyzers</li> </ul>	Estimated market size: <ul style="list-style-type: none"> <li>• &lt;EUR 200 million</li> </ul>	<ul style="list-style-type: none"> <li>• ABB</li> <li>• BTG</li> </ul>



# Pulp and Energy business line offering

Leading global technology supplier



## Pulp

- Chemical pulp mill
  - Wood handling
  - Cooking and fiber line
  - Pulp drying and baling
  - Chemical recovery
- Mechanical pulping
- Fiberboard defibrator systems
- Industrial Internet and remote support

## Biomass conversion

- Pretreatment for bioethanol production
- Black pellets
- Lignin extraction



## Energy

- Technology for biomass and municipal and industrial residual waste
- Fluidized bed boilers
  - Modular power plants
  - Gasification
  - Pyrolysis process
  - Industrial Internet and remote support

## Emission control

- Power plant flue gas cleaning
- Flue gas heat recovery
- NO<sub>x</sub> control
- Marine scrubbers



# Paper business line offering



- **Stock preparation lines**

- Recycled fiber lines
- Stock preparation systems
- Approach flow systems
- Broke collection and handling

- **Rebuilds**

- Modernization and upgrades for performance improvements

- **Stand-alone products**

- E.g., refiners, screens, pulpers



- **Board and paper production lines**

- Technologies for all board and paper grades
- Technologies for all size of machinery
- Tailor-made board and paper machines
- Modularized board and paper machines

- **Rebuilds**

- Modernizations and grade conversions

- **Stand-alone products**

- E.g., headboxes, sizers, winders



- **Tissue production lines**

- Technologies for all tissue grades and products
- Technologies for all size of machinery
- Conventional, textured and structured tissue production

- **Rebuilds**

- Upgrades for energy, product quality, safety and efficiency improvements

- **Stand-alone products**

- E.g., headboxes, Yankee cylinders, rewinders

# Full scope offering for the pulp and paper industry

## Technologies

- 1 Wood handling
- 2 Heat and power production
- 3 Chemical pulping
- 4 Chemical recovery
- 5 Pulp drying
- 6 Recycled fiber
- 7 Mechanical fiber
- 8 Stock preparation
- 9 Board and paper making
- 10 Tissue making

## Automation

- Distributed Control System (DCS)
- Performance solutions
- Quality Control System (QCS)
- Profilers
- Analyzers and measurements
- Industrial internet solutions
- Automation services
- Process simulators
- Safety systems and solutions

## Services

- Mill and plant improvements
- Spare and wear parts
- Paper machine clothing and filter fabrics
- Roll services
- Services for evaporation plants, power and recovery boilers
- Services for environmental equipment

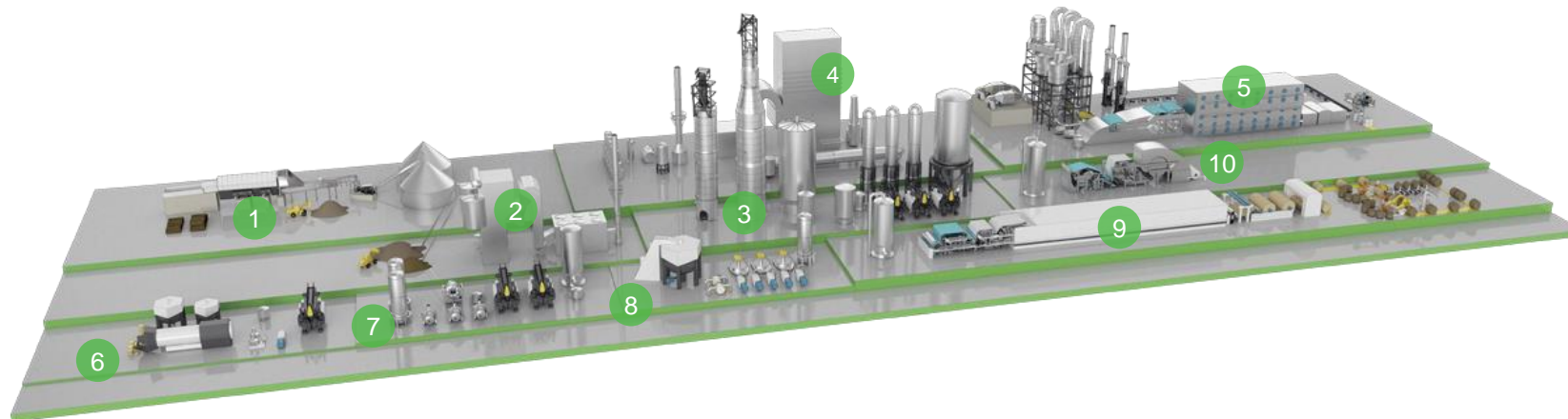

# Our offering for energy industry and biotechnologies

## Technologies

- 1 Fuel handling
- 2 Gasification
- 3 Boiler and flue gas cleaning
- 4 Bio-oil production
- 5 Modularized power plants
- 6 Prehydrolysis  
For biofuels, biomaterials and biochemicals, and bio coal production

## Automation

- Distributed Control System (DCS)
- Performance solutions
- Analyzers and measurements
- Industrial internet solutions
- Automation services

## Services

- Plant improvements
- Rebuilds
- Performance services
- Services for environmental equipment
- Components and spare parts
- Training

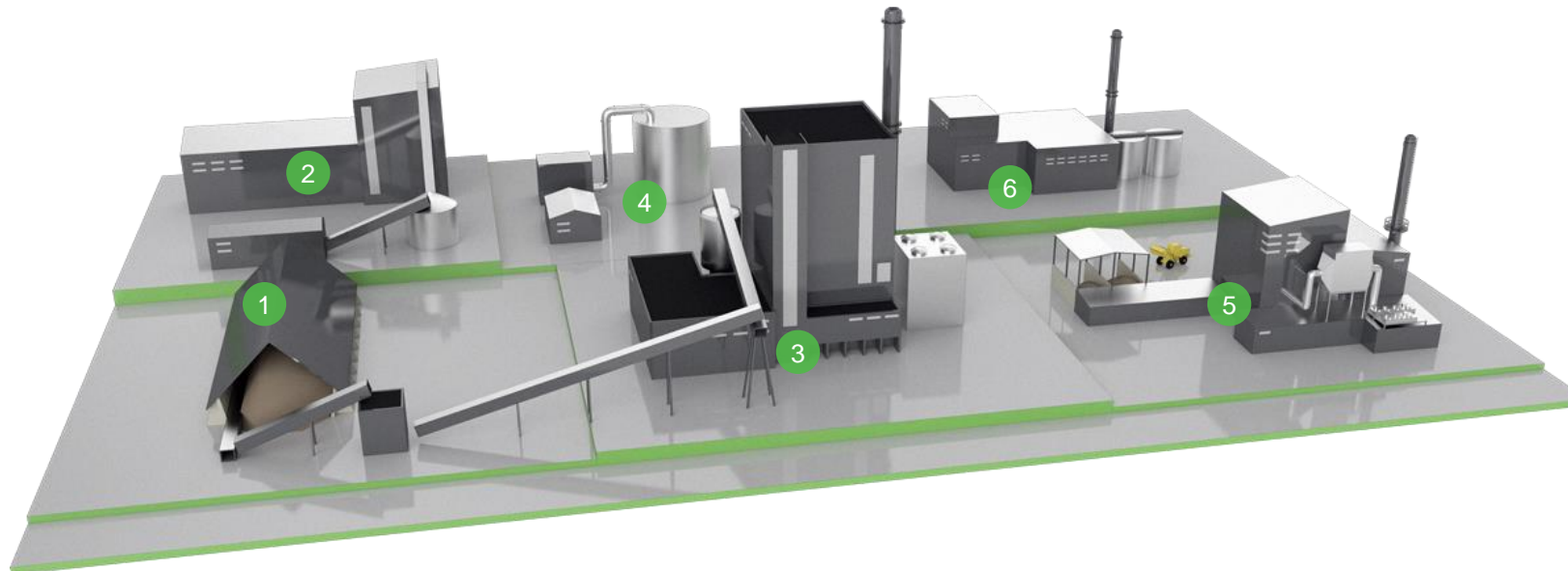



# Continuous investment in research and development to improve customers' processes



## Customers' needs

- Increase production efficiency
- Improve competitiveness
- Maximize value of raw materials
- Widen raw material base
- Provide high-value end products
- Develop new innovations and technologies



## Valmet's R&D focus

- Modularized and standardized products
- Energy, water and raw material efficiency
- Automation technology
- Biomass conversion technologies

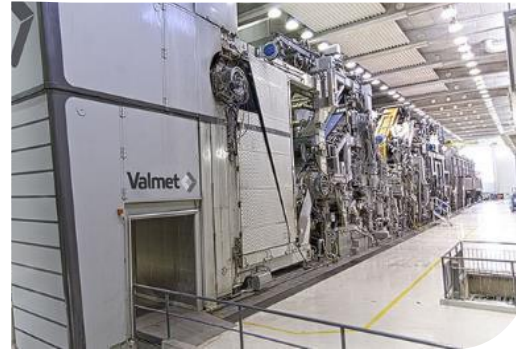

## Valmet's R&D resources

- Own R&D centers and pilot facilities
- Annual R&D spend EUR 98 million (2021)
- Around 1,300 protected inventions
- Cooperation with universities and research institutions



## Example of our R&D work – OptiConcept M board and paper machine

- Cost-efficient, high-quality, safe and flexible board making concept
- Significant savings in energy, water and raw material use
  - Energy efficiency improvement up to 30%
- Modular and compact size
  - Short delivery times, quick start-ups, and less production space
- Functional design brings increased safety and accessibility

# Business accelerator: Valmet Industrial Internet - VII

Dialogue with data to move our customers performance forward

## Recent development

- VII solutions in place for all customer segments
- Development of Mill Wide Optimization application
- Asset Performance Manager for installed base monitoring and fleet management

## Next steps and development actions

- Augment competence of people in control room through VII applications and Valmet DNA user interface
- Move towards more autonomous mills leveraging automation and process technology

## Valmet Performance Center delivering remote support



**2,900**

Remote support cases solved in 2021

**130**

Customers connected to Valmet cloud

**710**

Remote connections

**390**

Advanced Process Controls

# Typical dimensions of pulp mills, and paper, board and tissue machines

## Pulp mill

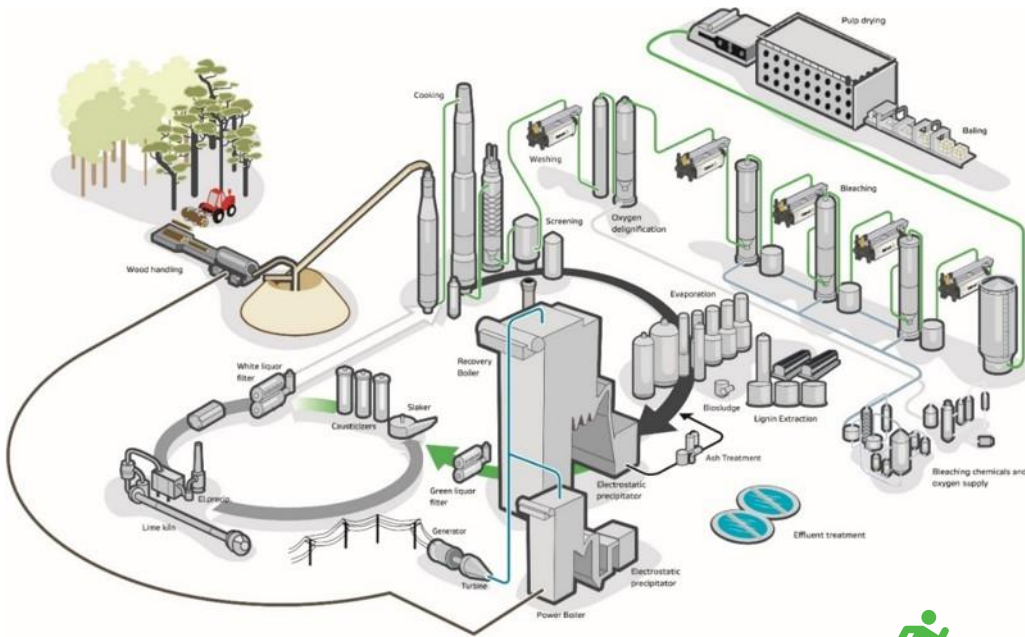

- Mill site area:  
500,000 – 5,000,000 m<sup>2</sup>, equivalent to **~70–700** football fields
- Built area:  
40,000 – 100,000 m<sup>2</sup>, equivalent to **~6–14** football fields



## Paper and board machine

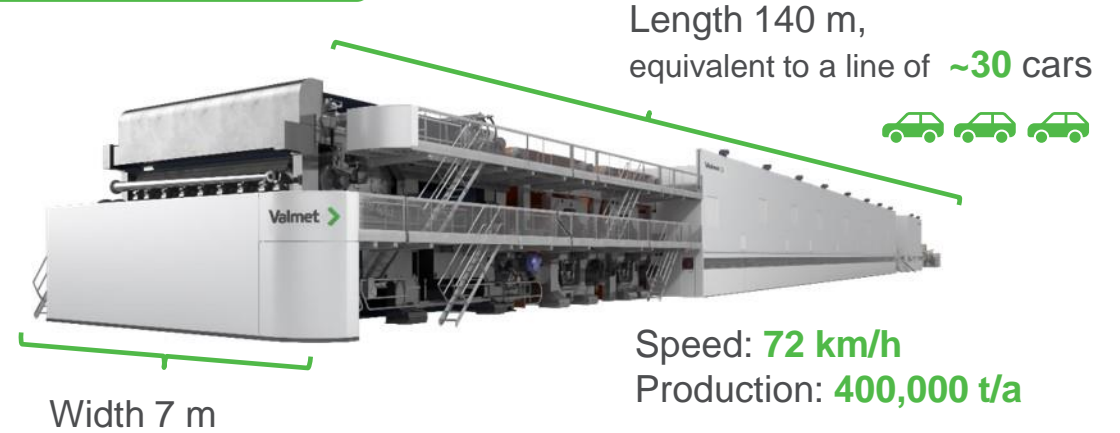

## Tissue machine

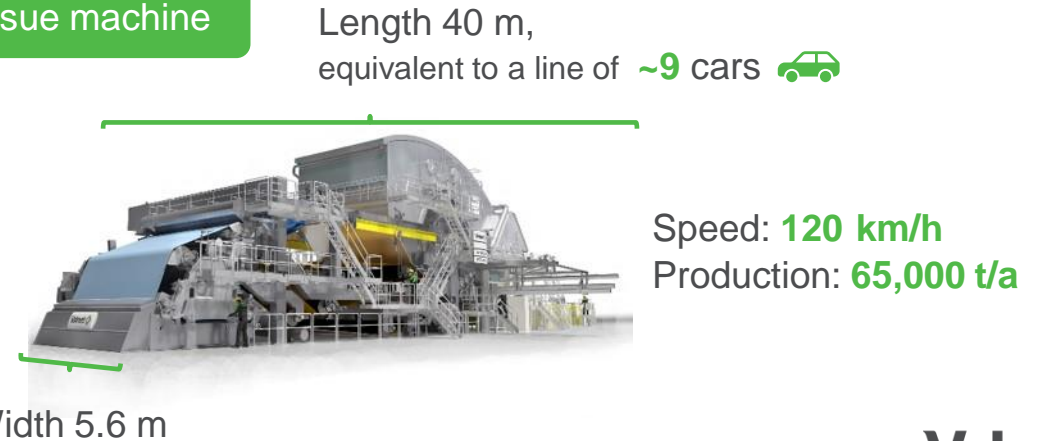



Appendix  
Management and remuneration



# Board of Directors



**Mikael Mäkinen**  
(b. 1956)  
Chairman of the Board  
Finnish citizen

- M.Sc. (Eng.)
- Other positions of trust:
  - Chairman of the Board of AkerArctic Technology Inc. and Corvus Energy
  - Board member in SSAB and Finlines Oyj
- Share ownership: 7,462
- Independent of company: Yes
- Independent of owners: Yes



**Jaakko Eskola**  
(b. 1958)  
Vice-Chairman of the Board  
Finnish citizen

- M.Sc. (Eng.)
- Other positions of trust:
  - Chairman of the Board of Enersense International Oyj, Varma Mutual Pension Insurance Company, Suominen Oyj and Cargotec Oyj
- Share ownership: 2,423
- Independent of company: Yes
- Independent of owners: Yes



**Aaro Cantell**  
(b. 1964)  
Vice-Chairman of the Board  
Finnish citizen

- M.Sc. (Tech.)
- Other positions of trust:
  - Chairman of the Board of Normet Group Oy and Technology Industry Employers of Finland
  - Vice-Chairman of the Board of Solidium Oy
- Share ownership: 8,408
- Independent of company: Yes
- Independent of owners: No



**Anu Hämäläinen**  
(b. 1965)  
Board member  
Finnish citizen

- M.Sc. (Econ.)
- VP, Group Treasury and Financial Services at Kesko
- Other positions of trust:
  - Board member of Finnish Fund for Industrial Cooperation Ltd. and Vähittäiskaupan Tilipalvelu VTP Oy
- Share ownership: 2,239
- Independent of company: Yes
- Independent of owners: Yes



**Pekka Kemppainen**  
(b. 1954)  
Board member  
Finnish citizen

- Lic.Sc. (Tech.)
- Other positions of trust:
  - Chairman of the Board of Nestor Cables Oy
  - Board member in Bittium Oyj and Junttan Oy
- Share ownership: 4,578
- Independent of company: Yes
- Independent of owners: Yes



**Per Lindberg**  
(b. 1959)  
Board member  
Swedish citizen

- M.Sc. Mechanical Engineering
- PhD, Industrial Management and Economics
- Other positions of trust:
  - Chairman of the BoD of Permascand AB and Nordic Brass Gusum AB
  - Board member in Boliden AB
- Share ownership: 1,634
- Independent of company: Yes
- Independent of owners: Yes



**Monika Maurer**  
(b. 1956)  
Board member  
German citizen

- Diploma in Physics and Chemistry
- Diploma in Pedagogy
- CEO of Radio Frequency Systems
- Other positions of trust:
  - Vice Chairman of the Board in Nokia Shanghai Bell, Co. Ltd
- Share ownership: 4,578
- Independent of company: Yes
- Independent of owners: Yes



**Eriikka Söderström**  
(b. 1968)  
Board member  
Finnish citizen

- M.Sc. (Econ.)
- Other positions of trust:
  - Board member of Bekaert, Kempower Oyj and Amadeus IT Group
- Share ownership: 5,708
- Independent of company: Yes
- Independent of owners: Yes



# Executive Team

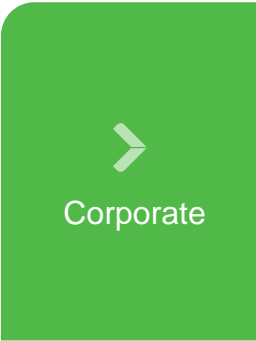

**Pasi Laine**  
President and CEO  
Share ownership: 177,137



**Katri Hokkanen**  
CFO  
Share ownership: 5,598



**Julia Macharey**  
SVP, Human Resources and  
Operational Development  
Share ownership: 38,319



**Anu Salonsaari-Posti**  
SVP, Marketing, Communications,  
Sustainability and Corporate Relations  
Share ownership: 31,350



**Aki Niemi**  
Business Line President,  
Services  
Share ownership: 63,222



**Sami Riekkola**  
Business Line President,  
Automation  
Share ownership: 16,433



**Simo Sääskilahti**  
Business Line President,  
Flow Control  
Share ownership: 1,437



**Bertel Karlstedt**  
Business Line President,  
Pulp and Energy  
Share ownership: 43,389



**Jari Vähäpesola**  
Business Line President,  
Paper  
Share ownership: 61,348



**Jukka Tiitinen**  
Area President,  
North America  
Share ownership: 94,330



**Celso Tacla**  
Area President,  
South America  
Share ownership: 94,129



**Vesa Simola**  
Area President,  
EMEA  
Share ownership: 52,971



**Xiangdong Zhu**  
Area President,  
China  
Share ownership: 30,617



**Petri Paukkunen**  
Area President,  
Asia Pacific  
Share ownership: 8,418

# Remuneration of the President and CEO

- The remuneration of the President and CEO is comprised of
  - fixed base salary (incl. taxable benefits<sup>1</sup>)
  - short-term and long-term incentives, and
  - pension and insurance benefits
- The relative proportion of the variable pay elements at maximum level is 2–3 times the fixed pay
- The President and CEO is recommended to own and hold Company shares equaling to the CEO's gross annual base salary (100 percent ownership recommendation)
- The notice period for the President and CEO is six months for both parties
- Severance pay (if the company terminates the agreement) equals to six months' notice period plus severance pay corresponding to the last total monthly salary multiplied by 18
- In 2021, the President and CEO's monthly fixed compensation was EUR 55,326 and the fixed annual salary EUR 697,106 (incl. taxable benefits<sup>1</sup>)
  
- More information can be found in Valmet's Remuneration policy and Remuneration report available at [valmet.com](https://www.valmet.com)

<sup>1</sup>) A company car and phone allowance.

# Remuneration of the Executive Team

- The remuneration of the Executive Team members comprises
  - fixed base salary (incl. monthly salary and taxable benefits<sup>1</sup>)
  - short-term and long-term incentives, and
  - a supplementary pension plan
- Additional pension benefit in the form of a defined contribution pension plan equaling 15–20% of base salary depending on role
- Notice period is six months for both parties. If the company terminates the agreement, there is an additional severance pay equaling six times the last total monthly salary

<sup>1</sup>) Such as a company car and a phone allowance, according to the local legislation and market practice.

# The Performance Share Plan for Executive Team members

- Includes a three-year performance period parallel to a one-year performance period
- One-year performance measures are based on long-term strategic and financial targets. They are measured independently and have remained the same for the past eight years.
- One-year performance period followed by a two-year restriction period, vesting after three years
- Includes a recommendation for the members of Valmet's Executive Team to own and hold an amount of Company shares equaling their gross annual base salary (100% ownership recommendation)

	<b>Long-term incentive plans 2021–2023</b>		<b>Long-term incentive plans 2022–2024</b>	
<b>Plan name</b>	Performance Share Plan and Deferred Share Plan	Performance Share Plan	Performance Share Plan and Deferred Share Plan	Performance Share Plan
<b>Performance period</b>	2021	2021–2023	2022	2022–2024
<b>Incentive based on</b>	Comparable EBITA as a percentage of net sales, and orders received growth in the stable business	Predefined strategic target	Comparable EBITA as a percentage of net sales, and orders received growth in the stable business	ESG Index, targets linked to implementing Valmet's Climate Program and Sustainability Agenda
<b>Reward payment</b>	In spring 2022	In spring 2024	In spring 2023	In spring 2025

