

Valmet Technical Paper Series

Improving Winder Safety and Capacity

Executive Summary

Improvements in winding for paper and board are typically targeted to address issues of safety and capacity. Valmet's continuous development has resulted in the OptiWin Family of winders, which feature many capacity and safety improvements, most of which are also available as upgrades to existing winders.

The OptiWin Drum liner board winder at Greenpac is an example of a highly automated winder with many integrated safety elements. Safety has been designed into the winder by eliminating hazards with guards, safety latches and automation with safety grade PLCs.

Regular winder service will also point out improvements to be made, as seen at Stora Enso Huatai. Valmet was able to assist the mill to increase speed, reduce vibration and improve roll quality with small improvements and parameter optimization.

Recently mills in North America have chosen to rebuild their winders primarily to improve safety. The same incremental improvements can be made to any winder, and many of them are described in this white paper. Additionally, we review automation-related capacity and quality improving upgrades such as super-fast slitter positioning (FastPosit), tail end gluing, and controls systems and diagnostics tools such as WindControl and WindHelp.

Valmet has written extensively about winders in previous white papers, including "Controls Upgrade", "Rebuilding for Safety" and "Slitter Management" as well as numerous peer reviewed papers at industry technical conferences. We conduct winder user group conferences such as the 2015 conference in Biloxi, Mississippi, USA and winder-specific training sessions for operators and maintenance. These technical papers and training programs are made possible by Valmet's over one hundred years of winder research and manufacturing experience and hundreds of in-mill troubleshooting service visits.

Valmet continuously improves the winding process and is able to offer these incremental improvements in both new winders, such as the OptiWin Family, as well as separately on our own and other manufacturers' winders. The OptiWin Drum winder is the first topic of this white paper...

Reliable winding capacity at Greenpac Mill

The opening of the new lightweight linerboard plant at Greenpac Mill in Niagara Falls, NY, in the United States (featured in Forward magazine, Issue 1, 2014) is certainly newsworthy. For the new line, the mill chose an OptiWin Drum winder for its high capacity and reliability. This winder is perfect for showcasing all of Valmet's winder innovations.

High capacity without web breaks

The capacity of the Greenpac linerboard line is high, with a parent roll width of over 8 m and a designed production speed of more than 900 mpm. This sets high expectations for winder capacity as well. The minimized sequence time and speed kept in reserve are the keys to reliably reaching these capacity goals. Greenpac Mill needs just one OptiWin winder to reach its targets.

The winder capacity can be maximized under any circumstances when the acceleration and deceleration are controlled by Valmet drive controls (Figure 1). Over the last decade, the dynamics of the winder have been the main focus of research. With the results achieved, Valmet has taken a serious step towards increasing the designed speeds beyond 3,000 mpm. In this case too, drive controls enable more advanced control loops to control the tension levels under changing speeds. Valmet holds the winder speed world record of 3,201 mpm (10,502 fpm). Yet in the case of liner winders, capacity is as essentially a matter of sequence times, i.e. how rapidly can you restart the winder after stopping for a set change; very high capacity is reached even with lower operating speeds. This increases winder reliability, because high speeds are used only when needed.

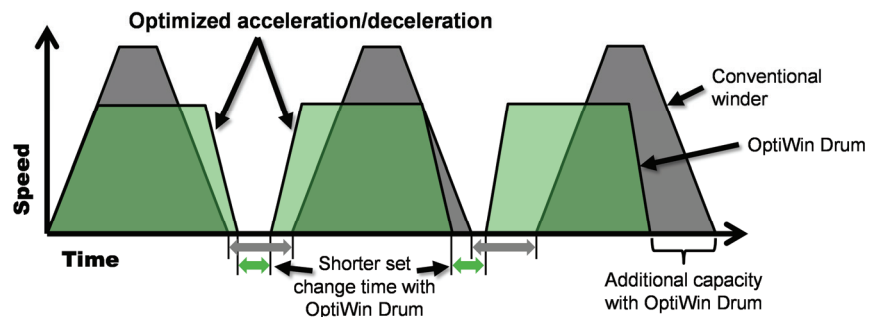

Figure 1. With Valmet winders, you achieve higher capacity even with lower speeds - thanks to faster set change time and maximized acceleration / deceleration rate.

Designed with efficiency and safety in mind

By removing bottlenecks in a paper machine and increasing the capacity, other issues may emerge. Existing winders are often too inefficient for paper machine capacity - winder capacity becomes the

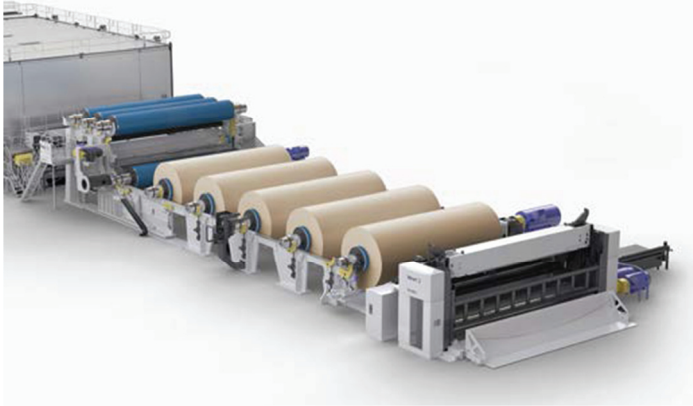

Figure 2. The OptiWin Drum winder at the Greenpac Mill is designed and constructed according to ISO 13849-1. The Occupational Safety & Health Administration (OSHA) adopted the machine guarding-related part of this standard in 2012.

bottleneck. In many cases, rebuilding the existing winder will not solve the capacity problem. With its compact size, high capacity, safety and fast installation time, OptiWin Drum (**Figure 2**) is the perfect solution.

Old winders do not comply with the most recent safety standards and regulations. The safety of old equipment can be considerably improved by rebuilding, but achieving a safety level similar to a new winder will probably require a costly investment. Safety may therefore become the decisive factor in choosing a completely new winder.

Safety is a built-in feature in OptiWin Drum winders. The first priority in a safe winder design is to eliminate all hazards. Remaining risks are prevented with mechanical guards and safety devices. Highly automated change and roll tail gluing eliminate or minimize the need for operators to access areas within winder frames. Access is prevented unless the winder functions are in a safe state. This means that movements of e.g. rider rolls and core locks are prevented with safety latches. The essential functions needed for winder operation can still be operated with hold-to-run controls.

All the safety equipment is connected to a safety PLC controlling and monitoring operator access. Safety circuits related to operator safety are provided with parallel redundancy; they are doubled to guarantee safe operation in all situations.

All the latest safety functions are in use at Greenpac Mill. OptiWin winders are viewed as the safest winders on the market.

Always ahead

The OptiWin winder is renowned for its high capacity and good reliability. No wonder, since Valmet has been introducing new technology to winders regularly. A very recent improvement is the traversing tail gluing technology also in use on the Greenpac winder. It gives the best tail fastening and is the easiest gluing device on the market in terms of maintenance and operation. This device saves on running costs (labor and adhesive costs), and maintenance costs are also reduced over its entire lifetime.

However, improvements in winding can also be achieved by making carefully planned modifications to existing winders, as witnessed in the following case study of winder service...

Customized winder service ensures efficient operations at Stora Enso

The quality of customer rolls is greatly influenced by the winder. Unstable performance can result in major losses and headaches, whereas reliable performance can reduce costs and offers peace of mind. One

mill that has benefited considerably from Valmet's regular on-time preventive maintenance solutions and professional mill site services is Stora Enso Huatai in China.

Established in April 2006 and located in Dongying, Shandong Province, China, Stora Enso Huatai (Shandong) Paper Co. Ltd. is a joint venture of Stora Enso Group and Shandong Huatai Paper Co., Ltd. Previously located in Germany and then migrated to China, PM 6 produces recycled fiber-based super calendered paper (SC). The grade is widely used, for example, in advertising materials, mass circulation magazines, catalogs, newspaper inserts, mail orders, and supplements.

The production line features a belt-supported OptiWin Belt winder supplied by Valmet. The winder became operational at the end of 2007. The winder is able to turn nip load sensitive paper into large, high-quality shipping rolls by controlling the nip load and making tight paper rolls through the application of high winding force from the driven belts.

Since the start-up of the winder, local Valmet service people have been providing the mill with customized winder process know-how, improvements, and maintenance services. "My cooperation with Valmet goes back ten years to the time when I worked at PM 9 and PM 11 in Shandong Huatai Paper," says Bin Li, Winder Supervisor at Stora Enso Huatai. "The technology that Valmet's mill site service uses is advanced and their service quality is very good. These are the reasons why we trust Valmet and why we have chosen the company as our preferred supplier for the winder. In fact, we have improved our winder performance a lot by working with Valmet."

Valmet's mill site service team in China was established in 2005 to provide fast and effective service for pulp and paper mills. The work of the team is summed up nicely by the Chinese saying: "When the medicine comes, the symptoms are alleviated".

Increased speed and capacity

In April 2011, when Stora Enso Huatai was adding a new paper grade to its production range, it was necessary to upgrade and optimize the winder. Not only was its speed too low for the new grade, but also major vibration developed in the winding area.

The mill contacted Valmet's mill site service and an expert was immediately assigned to the job. To begin with, the winder's mechanical components were checked for wearing. Then, to keep the vibration at a good level and all rolls in tolerance, mechanical alignments were checked and corrected. Also, new winding parameters were created to produce high-quality shipping rolls out of the new paper grade.

Valmet also arranged on-site training for the mill operators. The training better acquainted them with the winder so they could locate possible problems, analyze the paper by using the proper tools, and use the Valmet winder automation system more efficiently.

As the result of all these winder performance improvements, the winder speed was increased from 1,600 mpm to 2,000 mpm, which meant an increase in winder capacity.

Dishing problem eliminated

In September 2012, a dishing problem with the winder developed causing uneven roll edges and resulting in poor roll quality. Despite their best efforts, the Stora Enso Huatai staff could not find the reason for the problem. Valmet was contacted to provide deeper insight into the winding process.

After a careful winder inspection and the elimination of some possible causes of the problem, the real reason was discovered. The winder rear drum surface roughness had reduced over time, making the winding force uneven. Valmet fixed the problem by recoating and re-aligning the rear drum. In addition, the winding recipe was optimized, and the tension transmitter was replaced. With these measures, it was possible to improve roll quality and eliminate the mystery dishing problem.

Now let's review rebuilds that use primarily mechanical methods to reduce risk to operators...

Mechanical rebuilds to improve winder safety and capacity

A number of paper and board manufacturers in the United States have recently rebuilt their winders because of the need to improve safety in the finishing area. Winding, unlike the paper machine, is a batch process, and therefore entails different risk factors. Operators must regularly enter the winder area to perform functions, and machine movements are made as part of the roll building, set change, parent reel change and splicing processes. By rebuilding a winder to adhere to the latest international, national and mill corporate safety guidelines safety is improved.

For example, as mentioned in the Greenpac winder section of this paper, mechanical locks can be added to key moving elements in the winder such as roll ejector, rider roll and lowering cradle. Modern safety PLC I/O is usually added to replace or augment existing I/O. Safety PLCs and I/O have more diagnostics and redundancy, for a high level of reliability. The safety I/O has point level diagnostics and LEDs which allow maintenance to quickly identify a problem to reduce machine downtime. Permissives for machine movements are interlocked and combined with new fences, guarding, light curtains, laser area scanners, safety gates and mesh retractable safety gates to create safety zones in and around the winder.

In most winders undergoing a substantial rebuild, a main goal is to keep operators out of the machinery as much as possible, while improving the winder's cycle time safely. The following are examples from recent deliveries of rebuild elements that attempt to achieve this goal.

Safety latches

Latches and their corresponding sensors may be added at multiple locations in the windup area of the winder to prevent unwanted movements of the machinery in the event of power failures, etc. In the case of the lowering cradle, the intermediate position may have stop pins, which function similarly to latches.

Figure 3 (next page) shows a typical mechanical safety pin configuration. Common characteristics for safety latches include:

- an external proximity switch to sense if the pin or latch is retracted (i.e. disengaged)
- a proximity switch internal to the pneumatic engage/disengage cylinder to sense if the piston is extended (i.e. the latch is engaged)

- a spring internal to the pneumatic cylinder such that the latch engages in the event of loss of air pressure.

For every safety latch, there is positive determination via proximity sensors of the latch status – engaged or disengaged. In the event of a latch being commanded to engage and the proximity switch not detecting that it has engaged, that equipment cycle will be prevented until the situation is resolved. Similarly, if the latch has been commanded to disengage, but the proximity switch does not detect a disengaged condition, the equipment will not be allowed to cycle.

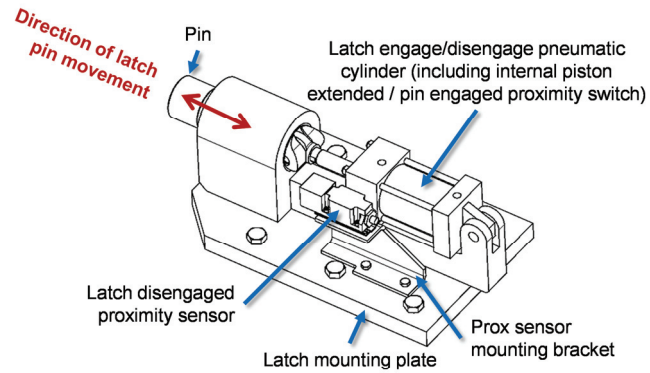

Safety pins are spring engaged, i.e. in the event of a loss of air pressure the pin will move to the engaged position to prevent movement of that section of the equipment.

Figure 3. Safety stop pin assembly with pin position sensor

Manually operated stop pins have also been used successfully in order to keep machine elements such as a roll ejector in a fully extended maintenance position. These pins are normally in storage positions mounted to the TS and DS frame when not in use. When the machine element is moved to the maintenance position, and before the maintenance occurs, the stop pins are removed from their storage positions and manually inserted (typically through the frame) into maintenance position holes in the machine element to be held in place. Proximity sensors are used to determine whether the pins are in the maintenance or storage location, and interlocked to prevent unsafe equipment operation.

Let's look at a few examples of safety latches and their locations on the winder.

Latches for rider roll and core chuck full raised positions

Mechanical latches on the tend side and drive side of the ratchet/pawl type may already exist for many rider rolls. Valmet provides position feedback for the latched and unlatched status of the safety latches on the tending and drive sides (**Figure 4**).

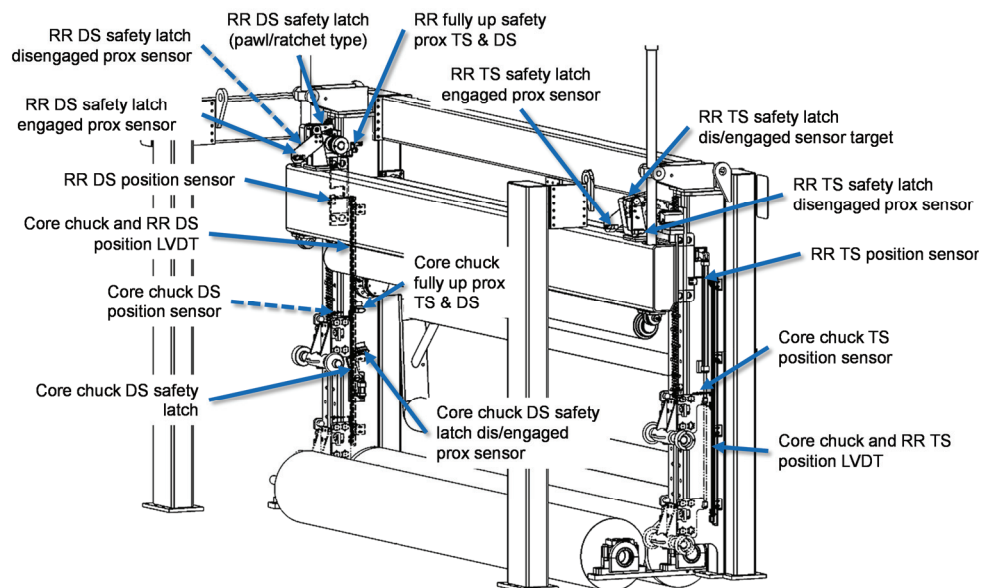

Figure 4. Rider roll full raised position latches, core chuck full raised position latches and new latch sensors

In the example in **Figure 4** the rider roll is held in the raised position with the existing mechanical latches during roll discharge, core insertion and threading operations. In addition:

- A safety rated limit switch is provided to indicate the rider roll is in the raised position.
- A light is provided to indicate the rider roll is in the raised position and latched.

In the example, new core chuck mechanical latches are also mounted on the tend and drive sides (**Figures 4 & 5 left**). When latched, the core chucks cannot lower unexpectedly.

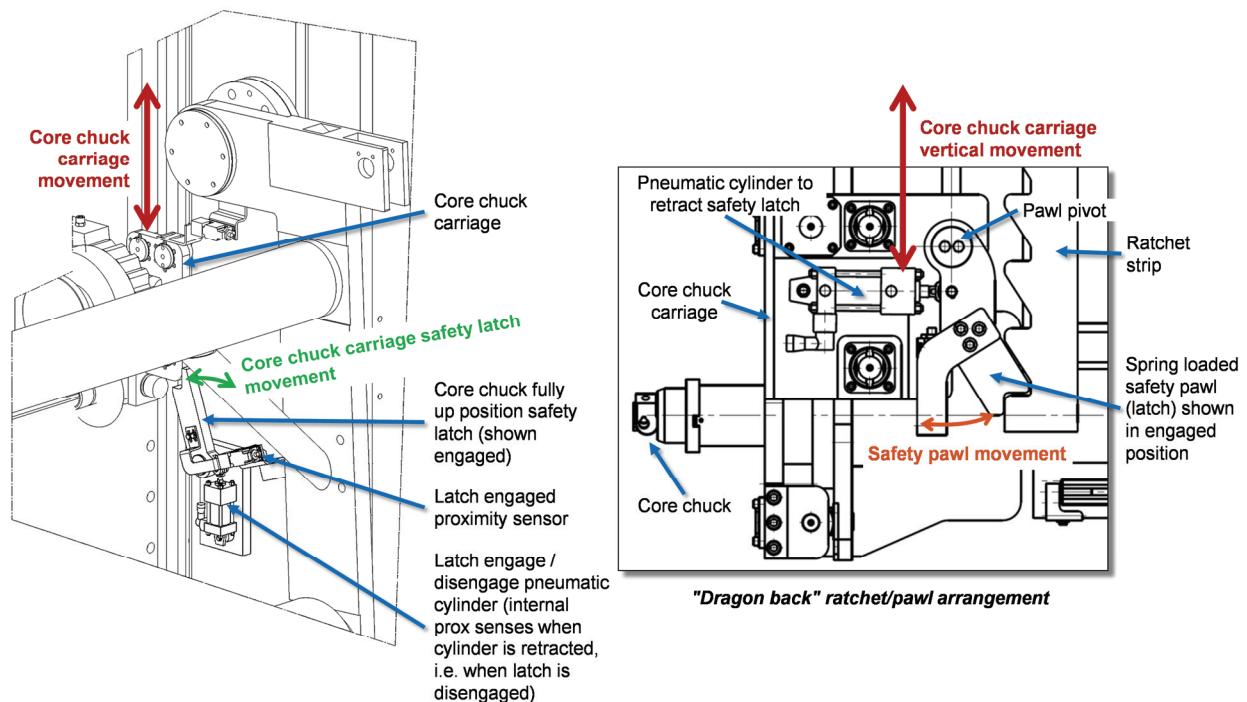

Figure 5. Core chuck full raised position latches and latch sensors (left) and "dragon back" safety ratchets and pawls (right)

Position feedback is supplied for latched and unlatched status of the safety latches on the tend side and drive side. The core chucks, tend side and drive side, are held in the raised position with the mechanical latches during roll discharge and core insertion.

Core chucks may also be equipped with "dragon back" stationary ratchet strips (**Figure 5, right**) mounted to the TS and DS winder frames. In this case, as the hydraulic cylinders are raising/lowering the rider roll, safety pawls prevent core chucks from dropping unexpectedly. The pawls remain spring engaged with the ratchet strip while raising the core chucks.

Holding pins for roll ejector home position

New mechanical holding pins may be mounted on the tend side and drive side of the ejector (**Figure 6, next page**). When engaged, the ejector cannot drift from its home position unexpectedly.

Position feedback is supplied for latched and unlatched status of the safety pins on the tend side and drive side. The roll ejector is held in the home position with mechanical pins during core insertion and threading.

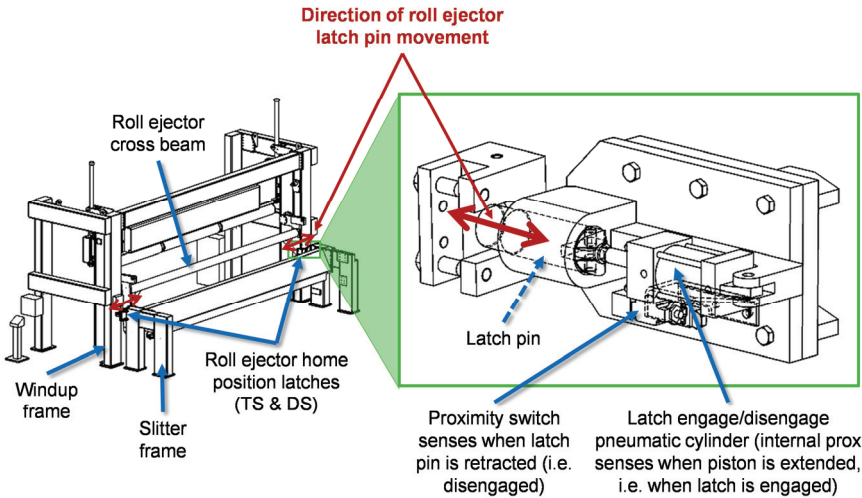

Figure 6. Roll ejector home position pins and sensors

The home position of the lowering cradle is in the raised position, ready to receive rolls. Safety interlocks restrict the movement of the lowering cradle. The lowering cradle receives the discharged set of rolls from the roll ejector, and then pivots to lower them toward the mill floor, stopping at a roll hold position if necessary.

When the intermediate stop pins are in place, the cradle cannot lower from the roll hold position unexpectedly. This, for example, will prevent lowering of the cradle when an operator is in the discharge

Stops for lowering cradle intermediate positions

New mechanical stops may be mounted on the tend side and drive side of the cradle (**Figure 7**). The mechanical stops are pneumatically actuated to release from an intermediate "roll hold" position.

The home position of the lowering cradle is in the raised position, ready to receive rolls.

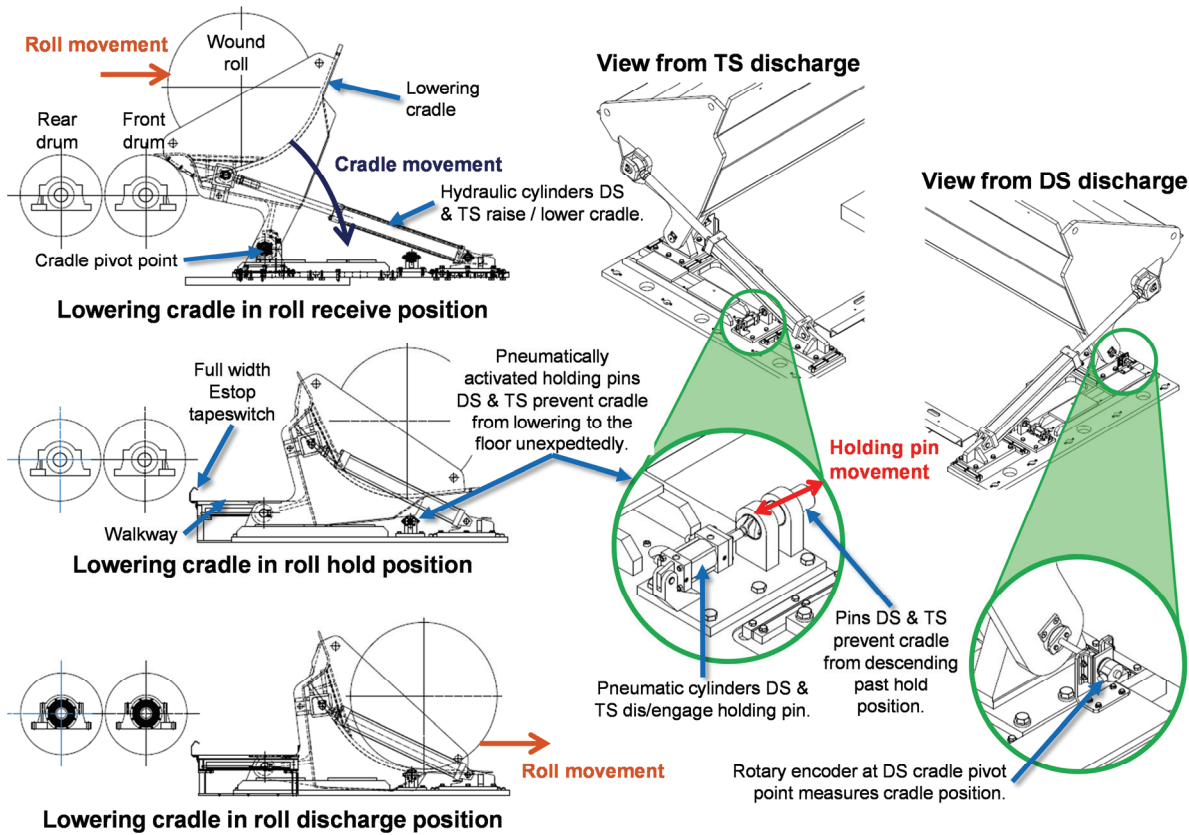

Figure 7. Lowering cradle intermediate holding position stop pins

area. When the discharge area is empty, the stop pins are allowed to retract and the lowering cradle may be lowered all the way to the floor. Some winders also use home position mechanical stop pins to hold the lowering cradle in a fully upright position in order for maintenance to be performed in the area.

In the example shown in **Figure 7**, an Estop tape switch is mounted just downstream of the front drum on the walkway lip. If the Estop switch is tripped, the lowering cradle will be disabled or stopped in mid-motion.

Safety zones and equipment

New safety fencing and equipment guards including pivoting, sliding and retractable mesh gates can be provided to restrict operator access to areas of the winder. This supports a safety zone design scheme that allows the winder to reach a safe state before personnel are allowed to enter a specific safety zone. The safety zones shown in the example in **Figure 8** are: reel and rail area, unwind and slitter section area, windup area, discharge area and winder pit area. There may also be local control panels mounted on the tend side of the winder within view of the machinery being moved. Horns and lights mounted along the top of the tend and drive side fences warn operators of moving equipment. We'll review this example winder's safety zones and interlocked equipment zone-by-zone.

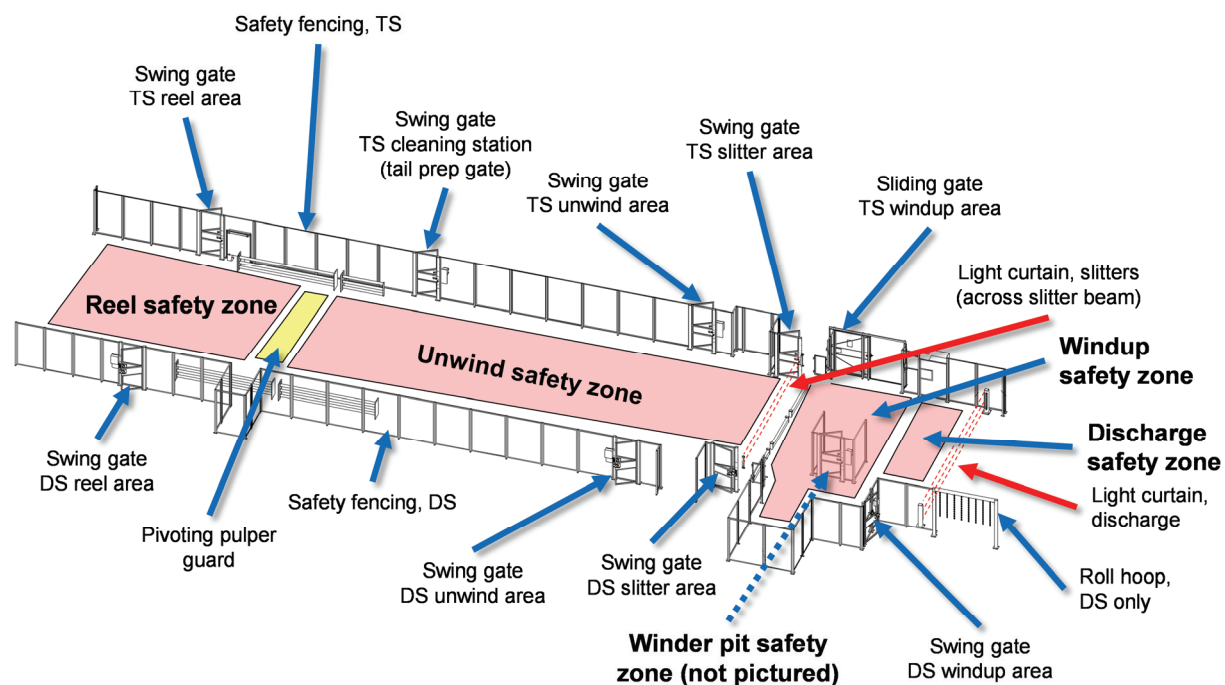

Figure 8. Example safety zones for winder with infeed rails from reel to unwind

Safety zones may change depending on operating status. In the **Figure 8** example, when the pulper guard is down, covering the entrance to the pulper, the unwind safety zone includes the reel safety zone.

Safety gates may be of many types. In the **Figure 8** example (also shown in **Figure 10**) the following types are used: swinging no key fortress lock, swinging 3 key fortress lock, and sliding 3 key fortress lock. Light curtains detect movement in the slitter and discharge areas.

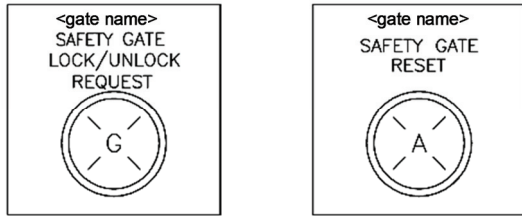

Figure 9. Typical safety gate controls

Safety gate choice and operation will be dictated by mill and government safety protocols, and Valmet will modify interlocks accordingly. In the example winder, to enter a safety zone, the operator must first push the Lock/Unlock Request button (**Figure 9**) located on a control station near the safety gate. The gate may now be opened. Some or all machine movements in the

safety zone are prohibited until the operator exits the safety zone, closes and latches the gate, locks the gate using the Lock/Unlock button and then resets the safety gate using the Reset button.

The Lock/Unlock Request illuminated pushbutton will be steadily lit when unlocked. It flashes when gates cannot be unlocked due to machine state. The Reset illuminated pushbutton is off when gates are locked and reset.

Some mills require safety gates to be tested regularly. For example, each gate must be used weekly to verify the safety monitoring signals. A warning alarm would appear at 6.94 days if a gate has not been tested. Then, if a gate has still not been tested at 7 days, when the winder is stopped and setchange sequence is off the gate would automatically unlock. The illuminated Reset pushbutton would flash slowly. The gate must then be opened and closed before locking and resetting. If a fault occurs with the safety monitoring of the gate lock then the illuminated Reset pushbutton will flash quickly. If the gate is not reset, safety monitoring is OK, and function test time has not expired then the Reset pushbutton will be steadily lit.

The safety zone example shown in **Figure 8** uses the equipment shown in **Figure 10**.

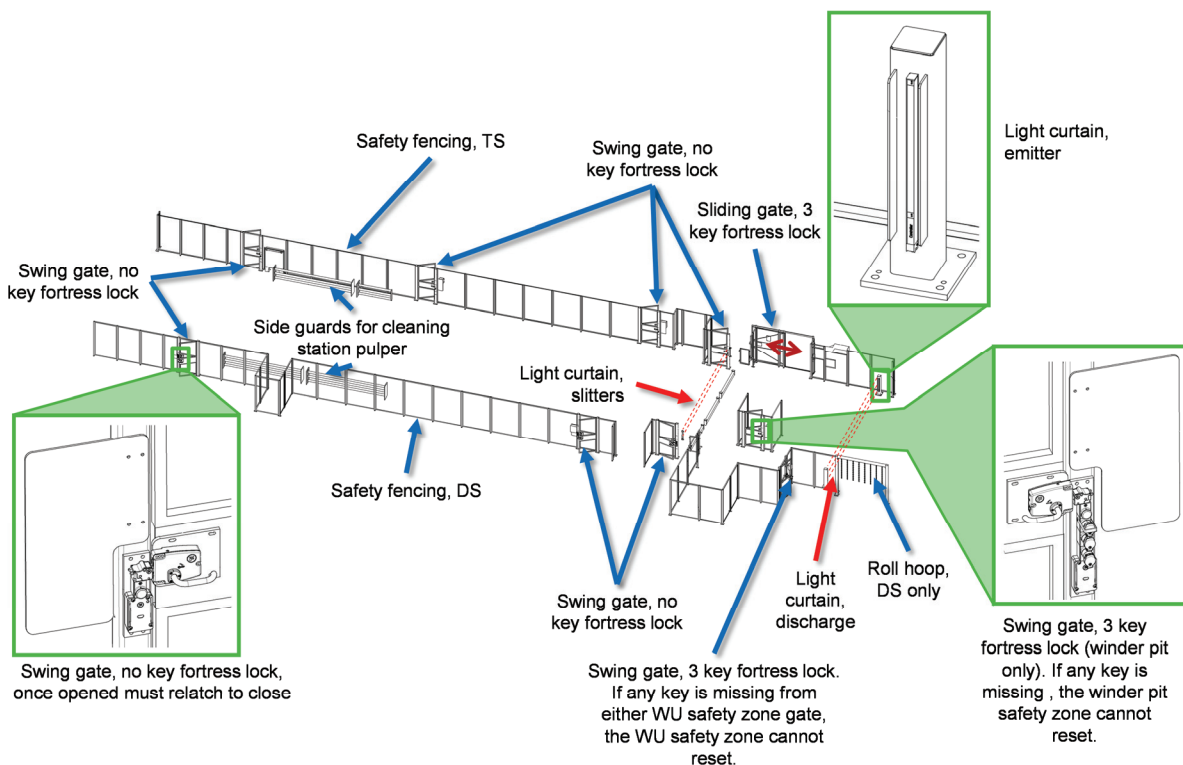

Figure 10. Safety fencing, light curtain and safety gate locations for example winder shown in Figure 8

In the case of the 3 key safety gates, to enter the area the operator must follow a similar procedure as explained previously, except he must remove one of the keys and keep the key while in the area. When exiting the area, the key must be inserted after closing the gate, before locking and resetting the gate.

In the **Figures 8 & 10** example there are two light curtains which will detect motion: one in the slitter area and one in the discharge area. In each case, machine movements in the corresponding areas are limited when there is movement detected by the light curtain. The discharge area light curtain must be reset after detecting movement. The slitter area light curtain resets itself once movement is no longer detected.

In a winder rebuild safety considerations do not have to be limited to the winder only. In the example shown in **Figure 8** winder fencing and gates are also provided along the rails from the board machine reel to the tail prep station.

Solenoid locking fencing gates are provided at the rail gates near the reel and at the unwind. The solenoid locking gates are provided on both the tend side and drive side. These solenoid locking gates along the reel rails do not include a trap key.

If a gate is opened, parent reels cannot be indexed to the next reel station until the operator exits the area, closes and resets the gate. Also, all pulper guards must be in place before a gate can be opened.

The example winder also includes new fencing from the tail prep station extending to the unwind stands and slitter section to prevent access to the tail prep, unwind and slitter areas.

Access to the unwind area is through the slitter section TS and DS gates or the tail prep TS gate or the unwind TS and DS gates. Entry to the unwind area is prevented when:

- The parent reel is transferring from the rail storage position to the unwind
- The spent spool is being lifted out of the unwind stands
- The winder speed is above 100 fpm

The slitter light curtain interlocks slitters and threading devices at the slitters. In the example, there is a winder pit, so fencing is provided under the top slitter beam to prevent access to the opening under the winder.

The example winder in **Figures 8 & 10** has guards provided for the core chucks. The guards enclose the core chucking assemblies beyond the winder frames. The guarding covers the complete travel on the core chuck assembly for the raise/lower operations. The chuck/unchuck operations have an enable switch that must be activated to use this function if the gates are open. An interlocked access door on the core chuck guard is provided for manually inserting the cores into the winder. This access door cannot be opened until the winder is at zero speed and the rider roll and core chucks are in the locked raised or down position.

Interlocked gates are provided between the winder and the cradle. These gates have a trap key. The interlocked switch cannot be reset until all trap keys have been replaced. Access is allowed when:

- Cradle is in the lowered or intermediate position
- Winder speed is at or below threading speed unless a separate roll barrier is supplied
- Tail gluer is in the parked position

Perimeter fencing is provided from the interlocked windup gates to the first roll deck stop. A light curtain is situated downstream of the cradle that detects movement in the discharge area.

An interlocked gate is located at the entrance to the windup walkway. This switch is provided with a trap key. To enter the wind up area, the operator must first unlock the gate remove the trap key and open the gate. The operator must keep a trap key with him/her the entire time while in the windup area. No equipment can operate until the operator exits the windup area, closes the gate and inserts the trap key in the latch and pushes the lock then reset button at the gate.

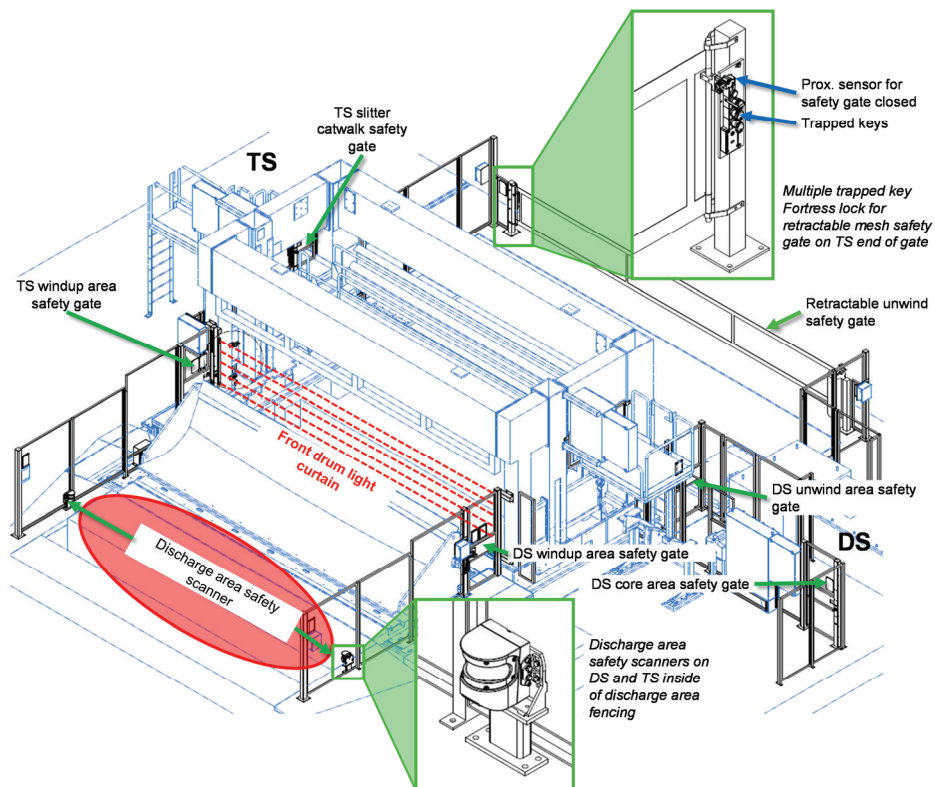

Figure 11. Example winder with retractable mesh safety gate and area laser scanners

Additional winder safety elements

In a different winder safety zone example shown in **Figure 11**, the winder uses safety scanners and a retractable (mesh) safety gate. The slitter light curtain disables slitter motors and movement while the curtain is broken, i.e. when operators are reaching into the slitter area. This winder uses a pivoting front drum splicing guard that doubles as a web cutoff knife (**Figure 12, next page**). The front drum light curtain disables front drum guard movement while the curtain is broken. The discharge area safety scanners disable any discharge area (lowering cradle) movement until the scanners are reset. The retractable unwind safety gate keeps personnel out of unwind and empty spool storage area and disables unwind movement while the gate is open and not reset.

The winder in **Figure 11** also includes a slitter catwalk. Adding walkways can improve safety in the winder area. On this winder the walkway is used for broke cleanup and maintenance. This prevents unsafe climbing into the winder.

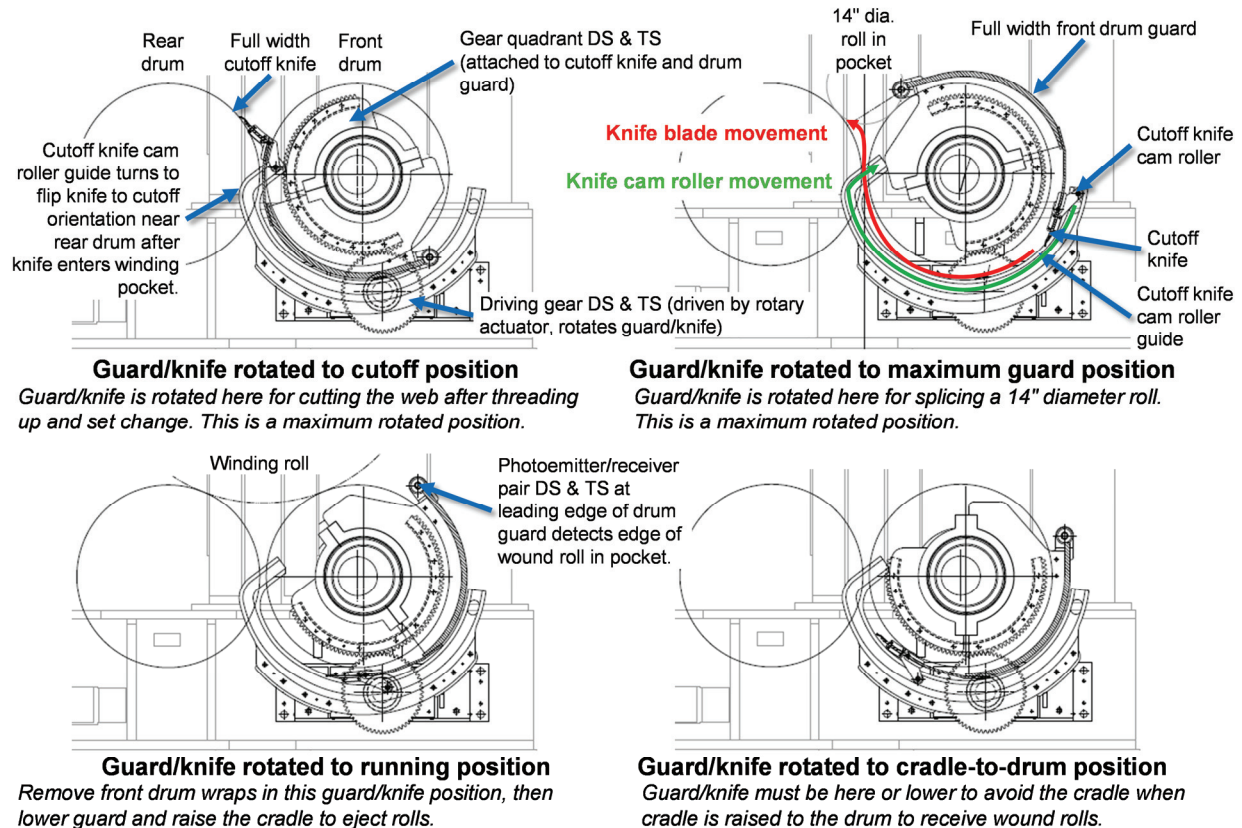

Figure 12. This innovative front drum guard also functions as a web cutoff knife.

This winder also included a crane hook stop at the drive side unwind stand. The crane hook stop protects the equipment by preventing the operator from lifting the reel spool from the stands when the drive coupling is engaged.

Hydraulic systems are frequently rebuilt with all new valves and manifolds for safety reasons. For these and other rebuilds, Valmet uses circuits that have been evaluated against EN ISO 13849. An example of a circuit level hydraulic safety upgrade might be adding a safety isolation directional valve to block the main valve for redundant safety operation.

In Valmet winder rebuilds, relevant signs are supplied to the latest ANSI standard Z535. Safety signs are pictorial and indicate the type of hazard and the severity of the hazard. The signs are mounted on fences and equipment near the hazard. Severity of the hazards described by Valmet safety signs are:

- "Danger" indicates an imminently hazardous situation which, if not avoided, will result in death or serious injury.
- "Warning" indicates a potentially hazardous situation which, if not avoided, will result in death or serious injury.
- "Caution" indicates a potentially hazardous situation which, if not avoided, will result in minor or moderate injury.

Improving slitting safety

Guards may be provided for the top slitter holders to cover the blade (Figure 13). Each guard can be hinged out of the way for blade change. Always remember that appropriate gloves should be worn during any blade or band change.



Figure 13. Slitter guard mounted on top slitter holder (example shows QuickChange holder)

QuickChange top slitter holder

An alternative to traditional top slitter holders is the QuickChange top slitter holder (Figure 13). Conventional top slitter holders use an effective but fairly labor-intensive system for locking slitter blades in place. The replacement procedure can take from 2 to 10 minutes, or even longer. With the QuickChange top slitter holders blade replacement can be done safely in a fraction of the time. No tools are needed for changing the blade. No locking screw is needed. The brake mechanism facilitates the replacement and improves safety. The new QuickChange top slitter holder is designed so that worn-out brake pads can be changed without the need to disassemble the holder.

Productivity is also improved since repositioning of the slitter carriages is no longer required, as blades located close to each other can now be changed. Since no tools are needed for the blade replacement, problems with jammed screws or broken screw threads no longer occur.

Designing a safer method for blade change was Valmet's main goal when developing the QuickChange slitter holders. Additional safety features include:

- The slitter release mechanism can be operated only when the slitter blade is not in slitting position. This function prevents accidental release of the slitter blade during winder operation.
- A brake system in the bearing assembly stops the rotation of the slitter blade when the blade is not in slitting position. This makes blade replacement easier.
- Visual verification ensures that the lock ring is in place.

The QuickChange slitter holders are available for all known winder top slitter thicknesses in paper and board making. The holders can be used with all types of top slitters – adapters are available to retrofit Beloit and Voith slitter carriages.

Fully Enclosed QuickChange top slitter holder

A further innovation is the Fully Enclosed QuickChange top slitter holder (Figure 14, next page). The encasing feature of our fully enclosed top slitter holder is designed to ensure there is no need to open the cover during normal operation. The top blade is shielded to protect operators' fingers during web threading. The blade change operation can be made even safer by using the optional magnetic blade cover to transport the blade between storage and the slitter holder.

A totally new design for controlling sequencing of the top blade to cutting positions avoids "jumps" onto the bottom band. The top blade has to move completely down before sideways movement is permitted. This removes the possibility of sequencing errors.

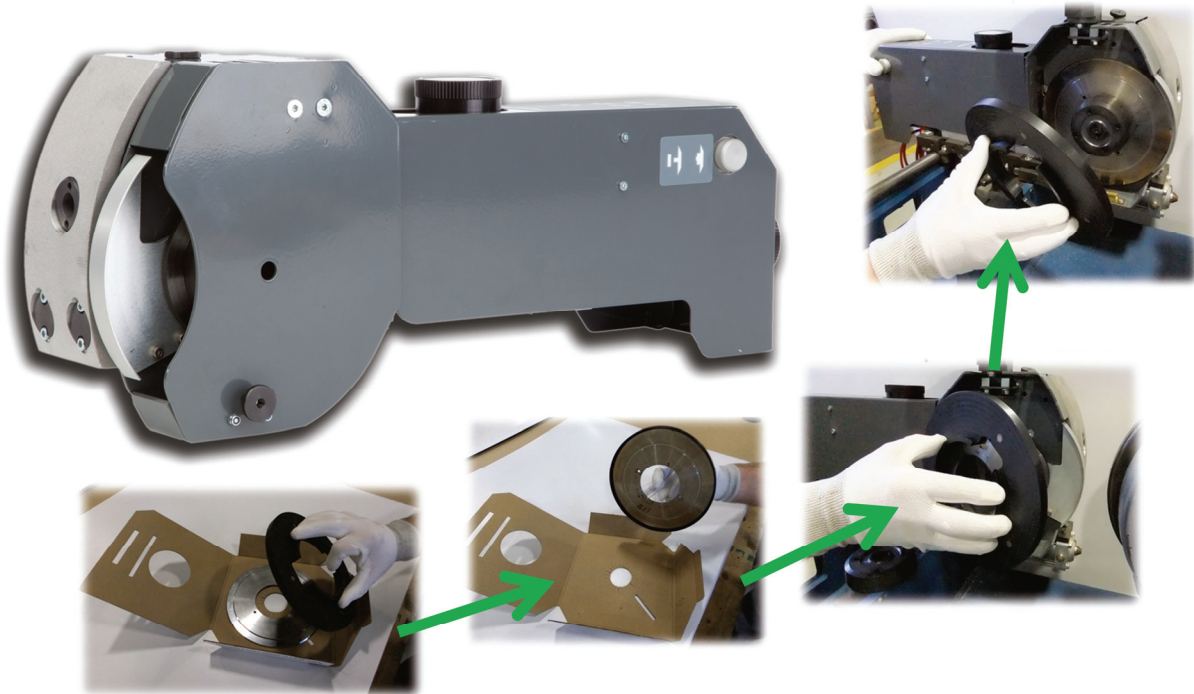

Figure 14. The Fully Enclosed QuickChange slitter holder (top left) provides the ultimate in slitter safety, and the magnetic slitter blade holder (smaller photos) further increases safety.

The depth and shear angle adjustments of the new top slitter holder help to produce a high quality cut with ease. The top slitter holder is equipped with easy to use push button valves. All control functions are marked with illustrative symbols. No specialized tools are required to remove the top blade lock ring.

Slitter Motor Change Tool for Valmet and Metso winders

It's not the most ergonomic working position to change the slitter motor. Normally a two person process, now there is no need for two people. Safety is improved because the possibility of back strain or dropping the slitter motor into the pulper or cellar is also reduced.

With a slitter motor change tool the change of a slitter motor is smooth, safe and a one person job. As seen in **Figure 15**. Just place the tray against the slitter motor and open the screws (top), slide the tray with motor toward you (middle) and lift the motor up and out (bottom).

Slabber Knife for safer slabbing

The Slabber Knife is ergonomically designed to allow an operator added safety while using the sufficient force needed to slab significant layers of material from the reel bottom. The

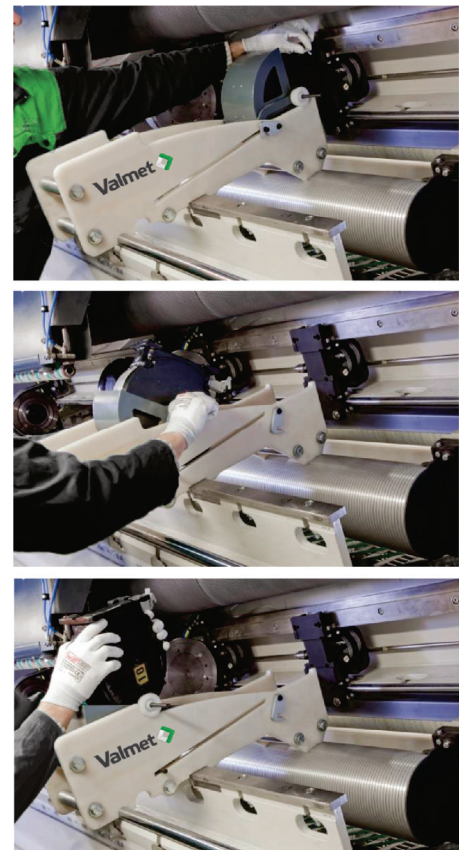

Figure 15. The Slitter Motor Change Tool simplifies and improves the safety of the motor changeout process.



Figure 16. The Slabber Knife improves operator safety while slabbing layers from the reel bottom.

knife is trigger activated so that when the trigger is depressed; the knife extends from the unit. The pressure exerted when pushing through the cut keeps the blade extended against a stop so you don't have to keep exerting pressure on the trigger mechanism when pushing through the cut. When the Slabber Knife (**Figure 16**) is taken out of the cut, the blade automatically retracts back into the unit.

When not in use, there is a safety mechanism that, when depressed, prevents the trigger mechanism from being activated and extending the blade. This is a good feature for transporting or carrying the Slabber Knife.

There are two handles provided for ease of use; the operator can determine which is more effective. The most commonly used handle is the side mount. It can be affixed onto the tool for either right or left hand operation. A center mounted round handle can also be used if that is more efficient; the choice is yours.

The Slabber Knife is beveled on the bottom so that it may be angled to one side or the other, which allows it to more easily slide through the cut. The blade depth is adjustable from 1/2" to 3/4". The blade itself is a typical utility or scoring type blade.

Automation for winder safety and capacity improvement

Automating operator activities will almost always improve safety on the winder. This may include many operations such as threading, set change, core handling, tail end gluing, slitter positioning, indexing of parent rolls along unwind reel spool rails and overall controls upgrades.

Set change sequences may be automated to minimize the time operators must be inside the winder safety zones. Safety in the slitter area can be improved with the addition of before slitter and after slitter threading devices to limit the amount of operator handling of the web near the slitter section during normal operations. These may be further augmented with air blows to assist in threading and splicing. Indexing of parent reels from the reel to the winder unwind avoids operator crane use and safely moves parent reels down a gentle slope under interlocked control. Cores may be measured, glued and inserted into the winder pocket automatically, keeping operators out of the core handling and windup areas. Rather than taping the end of the wound roll sheets to the individual rolls, end gluing may be used in an entirely automated manner, again keeping operators out of the windup area. All or most set change operations may be interlocked and function under automatic control by the PLC and graphic user interface.

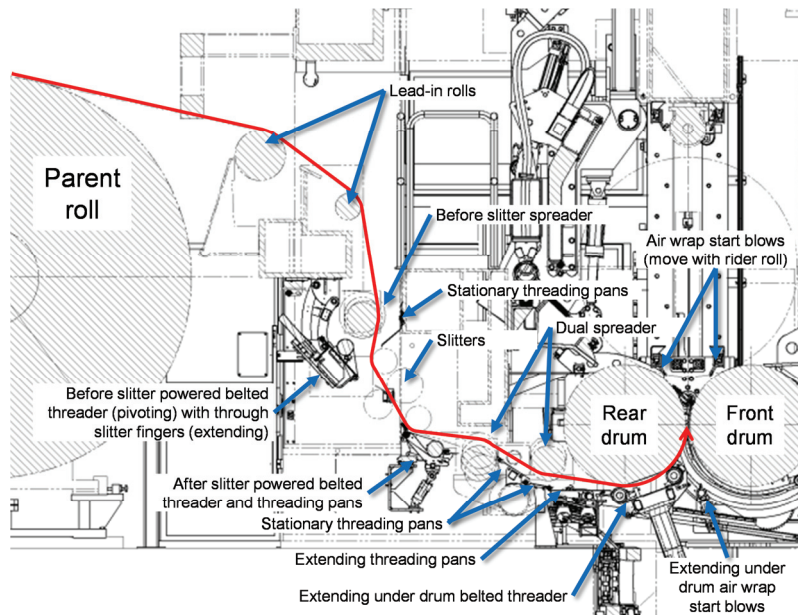

Figure 17. Example winder threading devices

the middle of the winder, and nips the tail to the roll. The tail is guided into the slitter section automatically, and is supported through the slitters by fingers which have extended from the before slitter threader.

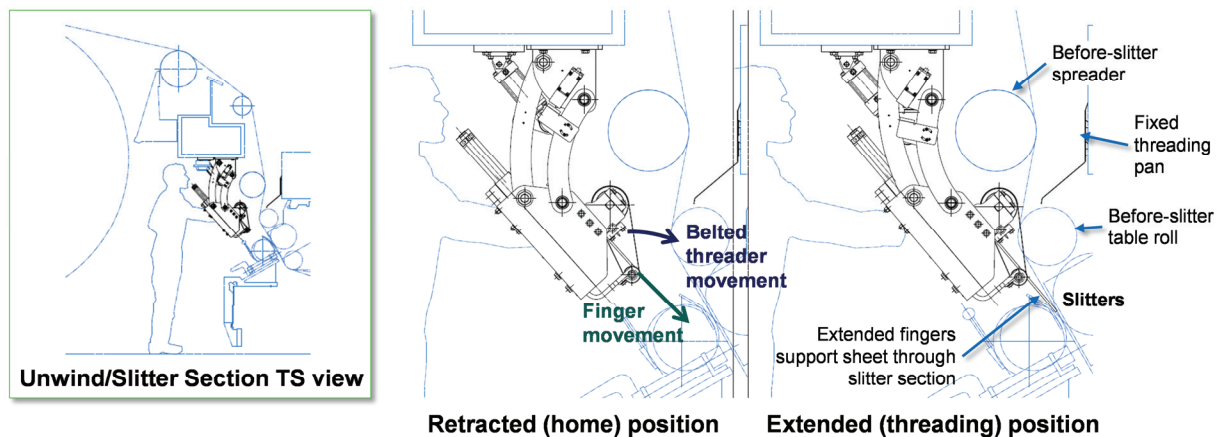

Figure 18. Before slitter powered belted threading assembly with extending fingers (as shown in Figure 17)

Automated parent reels on infeed rails

Stop/Kick assemblies on infeed rails may include safety levers (**Figure 19, next page**). When a reel rolls downstream along the rails and approaches a stop/kick assembly, a target arm is depressed by the weight of the reel, and is sensed by a proximity switch. The accumulator (part of the hydraulic cylinder) provides shock absorption as the reel contacts the stop/kick cradle. The cradle rotates to an intermediate hold position, holding the reel in position at the unwind station. The safety lever is engaged pneumatically, preventing the cradle from releasing the reel downstream in the event of loss of hydraulic pressure to the stop/kick cylinder.

Automating threading

The example winder shown in **Figure 17** includes threading devices before and after the slitter, stationary and moving threading pans, under drum threading device and air wrap start blows. The before slitter powered belted threading assembly in this example also includes "fingers" (**Figure 18**), so that operators do not need to reach anywhere near the slitters to thread the tail. In the example winder, the before slitter powered belted threader is located near the existing before slitter table roll in

When the downstream unwind station is empty, the stop/kick assembly is commanded to release the reel to the rails. At this point the safety lever is retracted, and the stop/kick cradle continues to rotate to the release position. The reel then rolls slowly downstream to the next rail station, or the unwind stands (if the reel was already in the last unwind station).

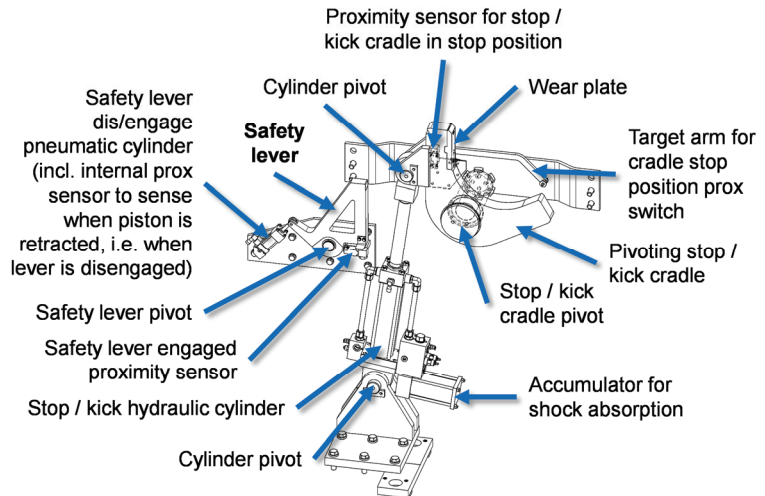

Figure 19. Typical parent reel infeed rail stop/kick assembly and safety lever

Automated core handling and gluing

Figure 20 shows core handling equipment located on an example winder that already had a core table conveyor. In this example, the equipment has been added between the conveyor and a new core loader

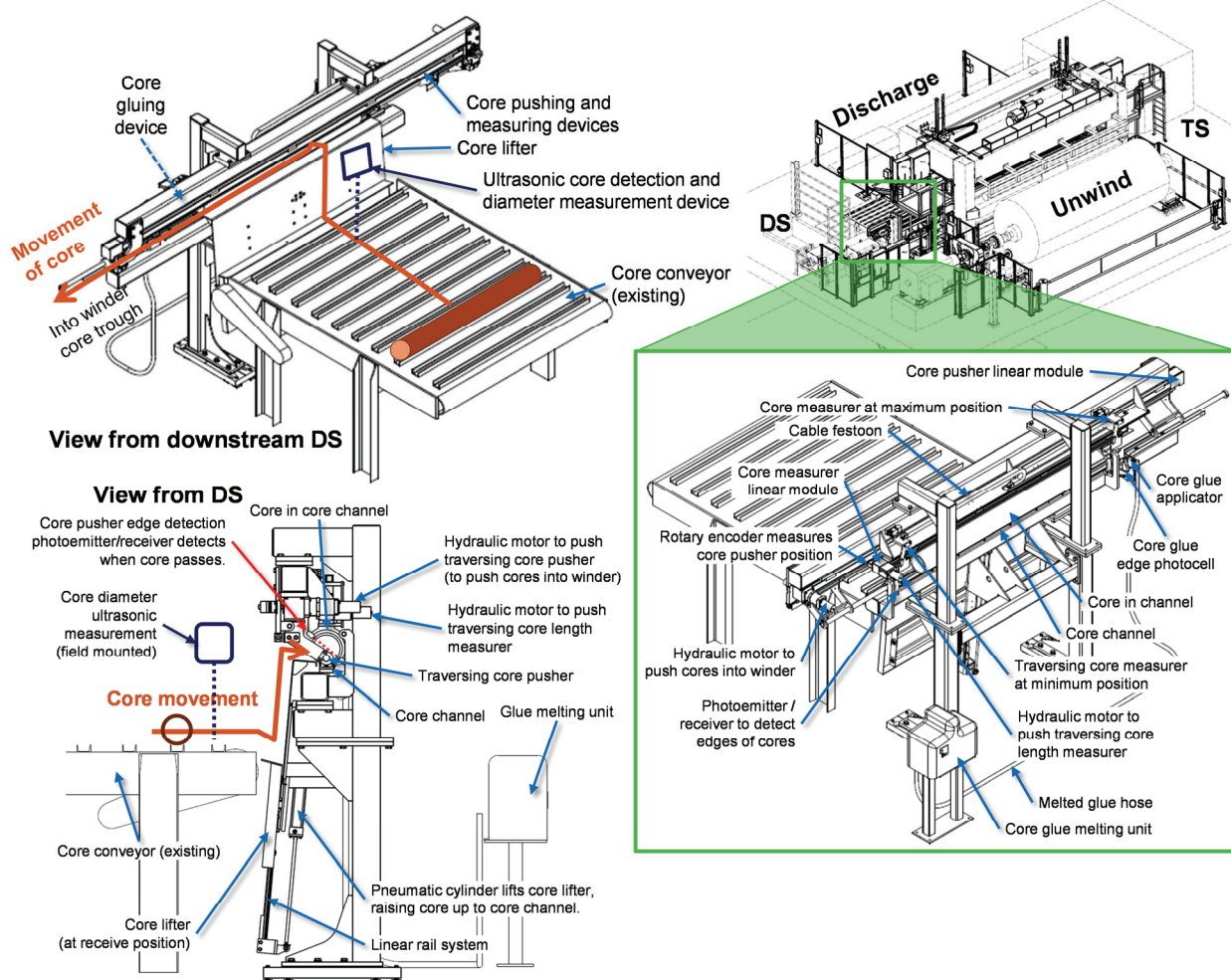

Figure 20. Automated core handling and gluing equipment

which is part of the roll ejector (not shown). Automating the core handling and core gluing processes improves capacity while increasing safety, as the operator is not required to access the core area of the winder except to load cores onto the end of the core table.

A core diameter ultrasonic sensor is mounted near the end of the existing core conveyor. A core lifter is provided to lift the cores from the existing core conveyor up into a core channel. The cores roll off the core conveyor and drop onto the core lifter shelf. The shelf raises pneumatically, lifting the core to just above the core channel. The core then rolls off the core lifter into the core channel. In this example the lifter is needed to raise cores to the proper height for a new ejector while allowing the existing core table to remain in its location.

Core measuring equipment measures the length of each individual core after it arrives in the core channel. Core pushing equipment pushes the cores into the core trough. This includes a linear module with internal linear guide and timing belt tow.

Core gluing equipment sprays hotmelt glue onto the bottom edge of the cores as they are pushed into the core trough. This winder uses a Nordson hotmelt ProBlue adhesive melter, with a plug-in hose/gun module and adjustment mechanism for different size cores.

A full width stationary core trough is located just below the home position of the new core loader. Sensing photocells and proximity switches determine whether cores have cleared the moving equipment and limit overtravel of moving equipment. A PanelView operator control panel located next to the core table allows local control core handling control and displays the cores that need to be loaded onto the conveyor.

Cores are conveyed on the existing conveyor under an ultrasonic core detector and diameter measurement device to the core lifter which lifts them up to the core channel. Each core's length is measured with a traversing core measurement device. The core is then pushed past the core glue applicator which sprays hot melted glue onto the bottom of the core.

The core is pushed into the core trough (not shown here) which extends full width below the core loader when the core loader / roll ejector is in its home position. As each core is pushed in by the core pusher, the cores already in the core trough are pushed toward the tend side. This process typically occurs when the winder is close to a set change. Multiple pushes are required.

Automating tail end gluing

A modern state-of-the-art tail gluing assembly will eliminate the need for operators to manually tape tails on the outside wrap of the wound and slit rolls. Such a system, located below the winder, is illustrated in **Figure 21 (next page)**. This particular system uses two traversing glue guns; however narrow winders only require one traversing gun.

As the last wrap of paper advances toward the winding pocket underneath the rear drum, while the drums are moving at very low speed, the glue is applied to the paper in a straight line in the cross machine direction. The paper then continues into the pocket and squeezes between the rear drum and the winding roll, firmly adhering the final wrapped layer. The cutoff knife will then cut the sheet after this point, leaving a short end of paper wound on the roll after the glued section.

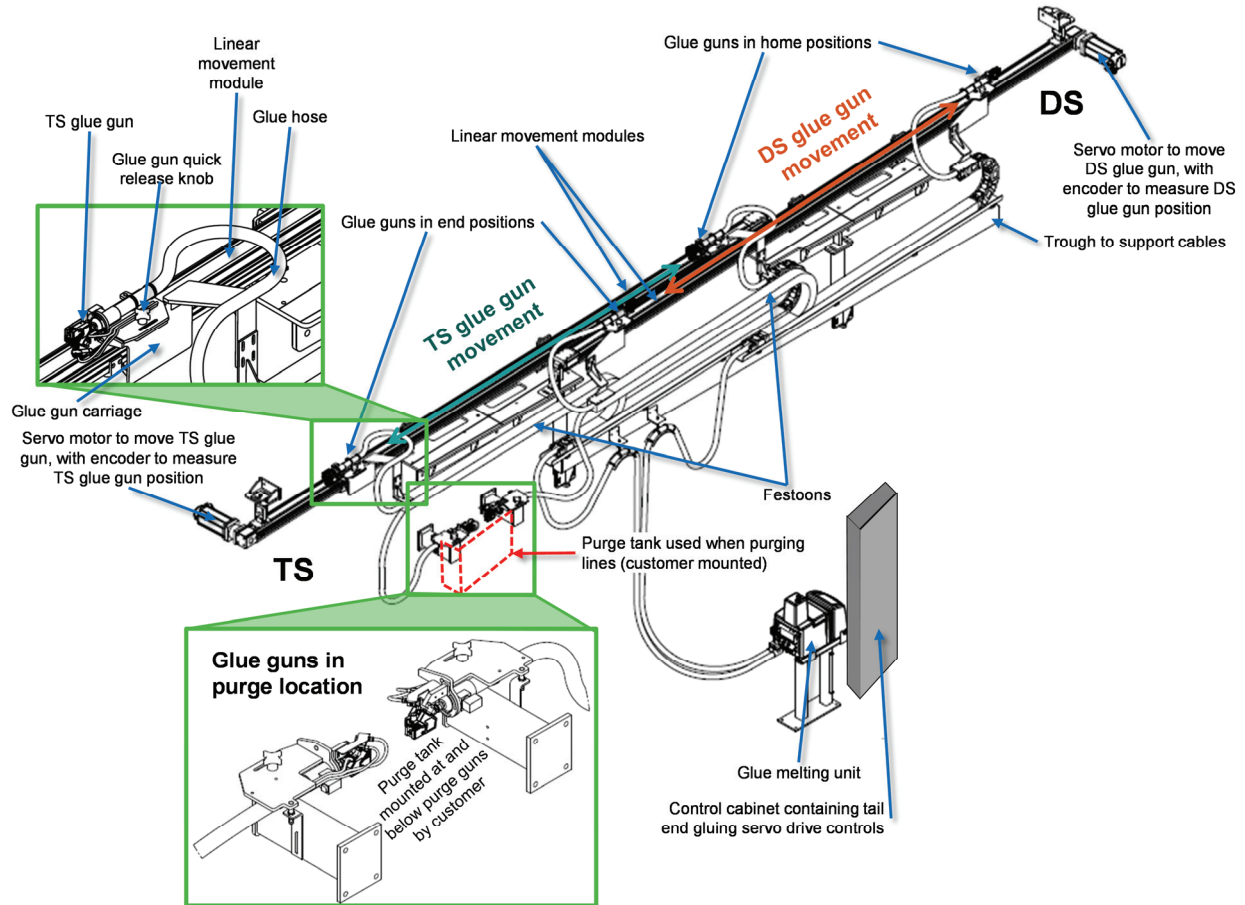

Figure 21. Automated tail end gluing assembly mounted in pit with servo controls located on basement platform

In order to get a straight CD line of glue, the traversing glue guns are canted a bit from the CD line to take into account the sheet movement in the MD direction. This winder is very wide, so two overlapping glue guns must be used, as one would not be quick enough to go full width and produce a straight glue line.

Periodically, the TS and DS glue guns are run to a purge position with the graphic user interface (GUI). Then the operator dismounts the guns from their carriages with the quick release knobs and mounts them to the purge tank. The GUI will then purge glue from the system.

In this winder, tail end gluing servo drive controls and melting unit require access to a basement platform, which is not part of a safety zone. However, maintaining and monitoring the hoses, linear modules, glue guns and carriages as well as purging the system require access to the winder pit. This is accomplished using the pit access gate located on the basement platform, then climbing a ladder to the winder pit. While in the pit all machine movements related to the windup area are prohibited.

FastPosit for ultrafast, automated, safe slitter positioning

Winder capacity and availability can be increased by minimizing winder downtime caused by slitter positioning during trim changes. Positioning with Valmet's new FastPosit slitter positioning system is extremely quick. Automatic slitter positioning increases safety by keeping the operators out of the slitter area except when changing blades and bands. In addition, safety is improved because the slitters in the middle of the winder can be moved to the sides out of the operator's way for tail threading.

With FastPosit, each top and bottom slitter carriage has its own linear motor for positioning and linear sensor for measuring its position (**Figure 22**). This allows each slitter band and blade to be positioned independently and immediately, resulting in significantly faster slitter positioning and winder restart. Manual positioning takes 180 seconds and conventional automatic positioning takes 60 seconds, but positioning with FastPosit takes only five seconds.

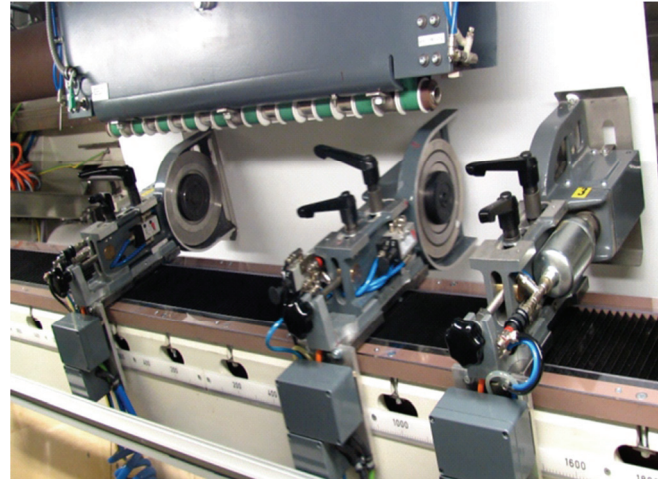

Figure 22. FastPosit slitter positioning moves the top and bottom slitters in only five seconds using separate motors and sensors for each top and bottom carriage.

The edge slitters can be transferred to the next target position while the web is still moving. The operator does not need to go to the winder to tear edge trim ribbons by hand, resulting in a further capacity increase.

A manual or automatic slitter positioning system can be easily upgraded into the FastPosit positioning system in just a two-day shutdown. This is possible by a preassembled module construction that is bolted to the existing winder frame.

The payback time for such an upgrade can be as short as a few months, depending on process variables. A trial run demonstrated that a transfer speed of 1,000 mm in five seconds will speed up positioning and thereby increase winder capacity by 5%.

The benefits of FastPosit include higher winder capacity, better winder availability, improved safety and more accurate roll width dimensions.

State-of-the-art winder controls

Valmet offers PLC and HMI (Human Machine Interface) control systems that use the latest safety hardware and process standards. A winder control system can be upgraded with up-to-date hardware and software packages, with the scope including either upgrading both the HMI system and the PLC system or just the HMI system.

WindControl for automated and optimized winding

The WindControl system (**Figure 23, next page**) is designed for winder operation, control and optimization of the winding process. The system performs all major tasks from management of winding parameters (speed, tension, winding force, rider roll load, autostop) to measurement of various process values of the system and automated machine movements including set change.

With a modern control system, the lifespan of the system is increased by 10-12 years as the control methods are current and spare parts are available. A configurable curve display allows easier tracking down of the reasons for customer complaints. A winding parameter recipe system leads to optimized and more uniform roll quality regardless of which shift of operators is running the winder. Automatic stopping is available based on unwind and windup lengths and diameters. Critical frequencies that may

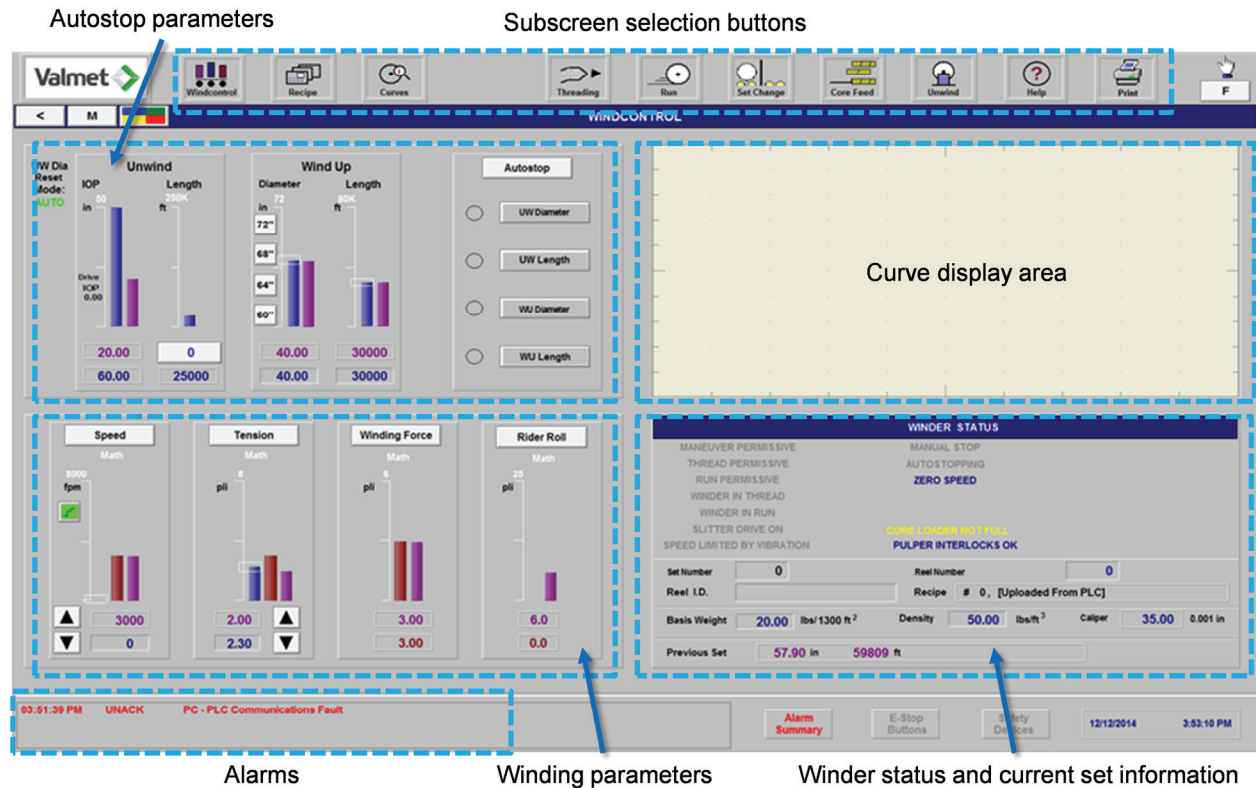

Figure 23. WindControl offers automatic stopping, set change sequences, curve history display, recipes and much more using this main screen and several subscreens.

excite the winding roll are avoided. The current status of all safety devices is displayed on a sequence of screens similar to that shown in Figure 24.

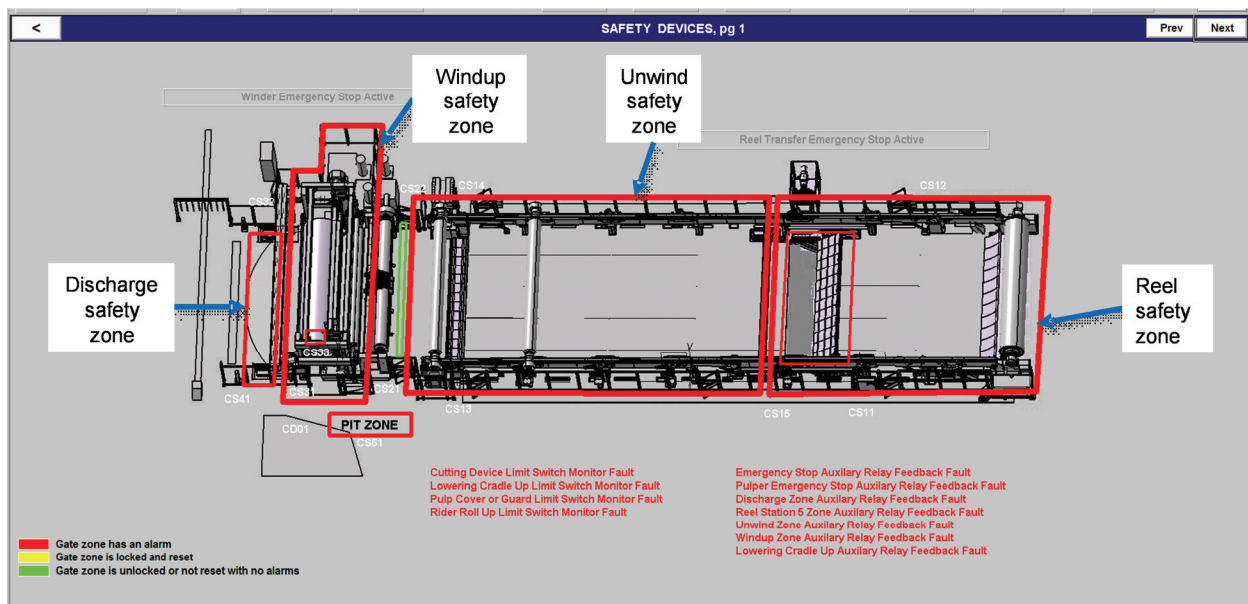

Figure 24. Safety device screens show the status of all safety devices and zones.

WindHelp for immediate operational assistance at the winder

WindHelp (**Figure 25**) is a tool for fast problem solving. It allows monitoring of the winder interlocks, sequences and alarms and is used by operators as a diagnostics and troubleshooting tool for winders. The system continuously scans each machine function and detects any non-functioning device. An alarm is set and the interlock signals from that device are displayed to the operator. Color is used to show which signals are in a fault state.

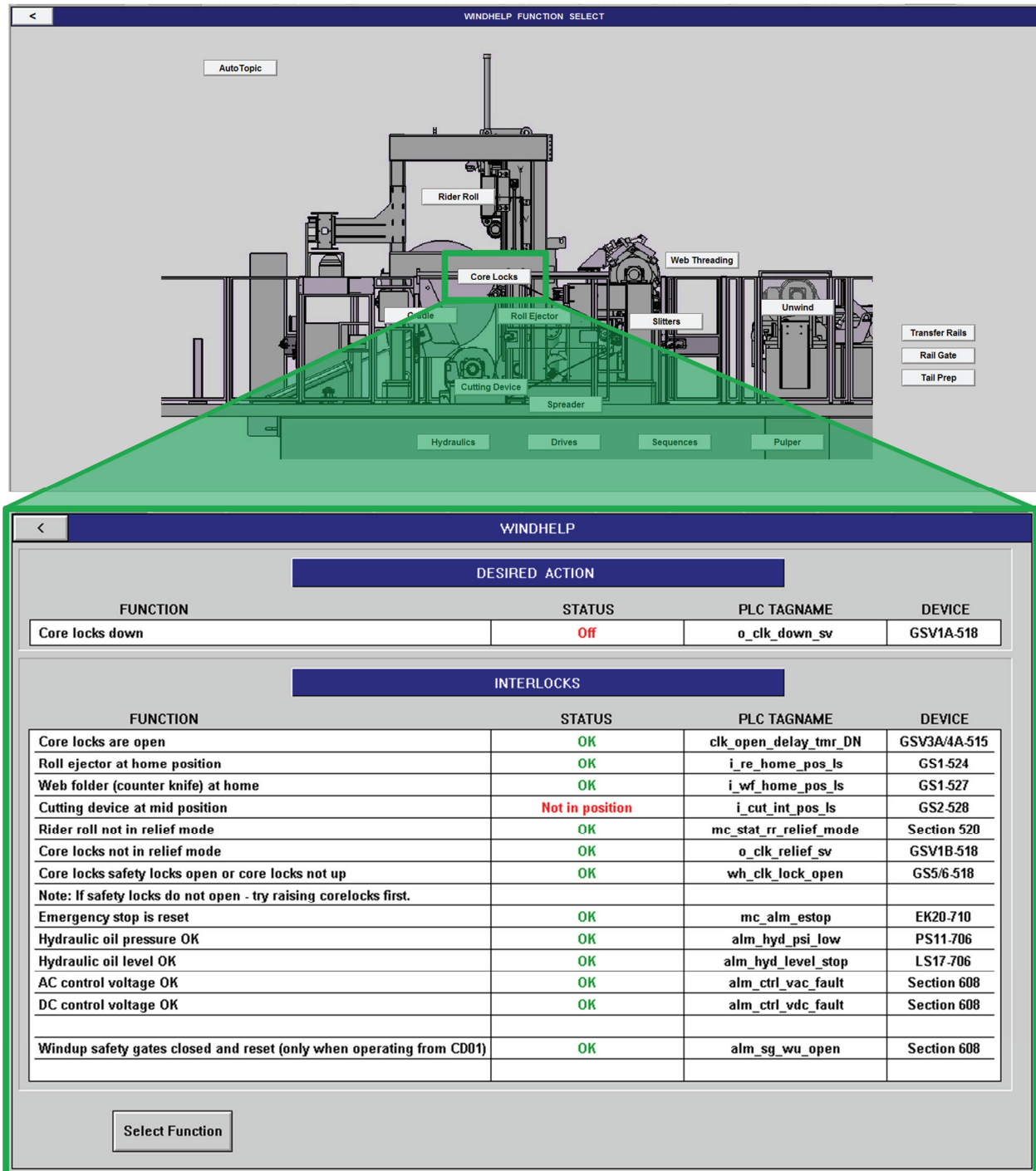

Figure 25. WindHelp clearly shows the operator or maintenance person what is preventing machine movement.

Mill maintenance personnel can also use the same tool for troubleshooting. The interlock signals behind different control functions are shown in WindHelp screens. The user interface can also display the status of drive permits, safety gates, photocells and set change sequences.

In **Figure 25**, the upper screen is the main WindHelp Function Select screen. First the operator chooses which area of the winder to diagnose by selecting machine movement function. Let's say the operator is trying to troubleshoot why the core locks will not lower. The lower screen in the figure shows an example of what the operator or maintenance person might see when using WindHelp to diagnose this problem.

In the example (lower part of **Figure 25**), in the DESIRED ACTION area, the STATUS of the Core locks down is "Off" and shown in red, telling us they are not down. Looking further down to the INTERLOCKS area of the screen we see that for the Cutting device at mid position FUNCTION, the red "Not in position" text is shown in the STATUS column.

Seeing this, the operator would then remove the interlock, in other words the reason why the core locks do not move down. This would require moving the cut-off knife to the middle position, after which the red text will change to "OK" green text and the core locks will now be able to move down. The diagnostic process takes much longer to explain than to use...

WindPosit for automated slitter positioning

WindPosit is Valmet's control system for automatically positioning slitters according to the trim widths entered by the operator. The two outer slitters are set up and designated as trim slitters and the slitters in the center are called intermediate slitters.

If a slitter is not functioning properly, or the operator simply does not want to use it, it can be removed from service using screen controls (**Figure 26, next page**). Slitters which are not available are referred to as "disabled" slitters.

In **Figure 26** the upper screen is a typical main WindPosit screen for a single servo drive transfer rod system. This screen is used to place slitter units in service, set up roll widths, monitor the position of the trim check carriage, and initiate slitter repositioning. The lower four screens are examples of selection diagnostics screens which provide the operator with clear graphical feedback regarding why a trim is or is not possible. There are several other subscreens for slitter position measurement, positioning times, usage, diagnostics, and trim recipe storage and retrieval.

In the automatic selection mode, disabled slitters are ignored by the control system. Slitters which are available, but not currently selected for cutting, are referred to as "out-of-service" slitters. Slitters which are currently selected for cutting are called "in-service" slitters.

Out-of-service and disabled slitter blade units remain retracted and will not respond to any slitter engage controls. The corresponding band unit remains in contact with the web, and is rotated to avoid marks on the web. However, out-of-service and disabled slitters still lock to and move with the transfer rods so that they do not interfere with other slitters.

Typically, all in-service intermediate slitter blades are programmed to engage/disengage as a group and the trim slitter blades are programmed to engage/disengage as a separate group.

All slitter motors are programmed to turn on/off as a single group, including slitters which are disabled or not in service. If an individual motor develops a problem, it can be manually taken out of service by maintenance personnel.

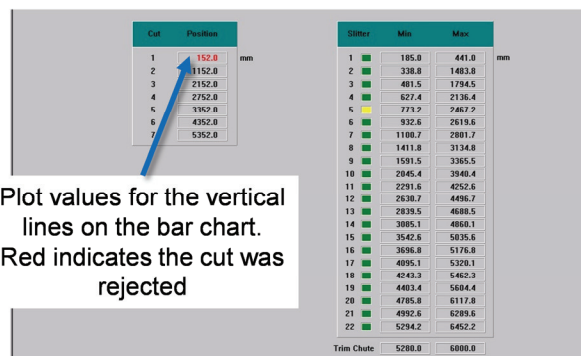
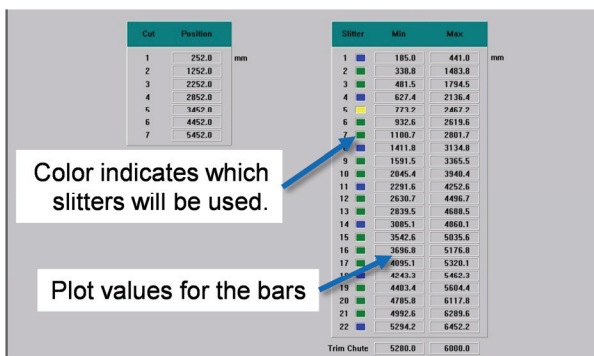
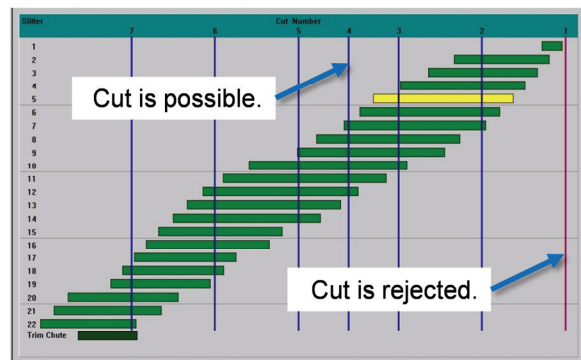
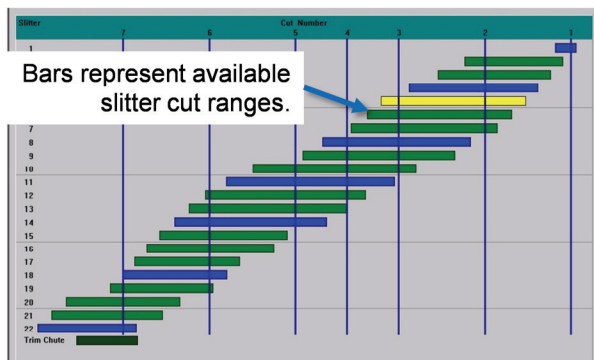
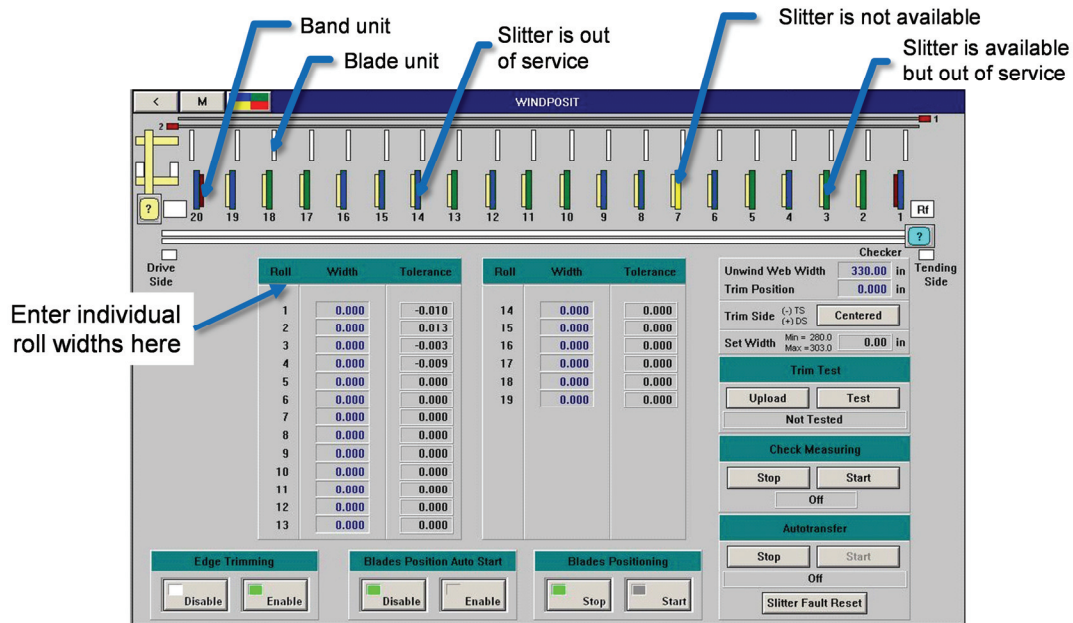

(a) Successful test

(b) Failed test

Figure 26. WindPosit automates slitter positioning and makes the entry and reuse of trim patterns easy.

Slitters require repositioning whenever the width of the wound rolls is changed. They may also require repositioning after a slitter blade or band change. On a typical winder using WindPosit rather than FastPosit positioning equipment, slitter repositioning is accomplished using the following equipment:

- the transfer drive assembly (physical positioning equipment)
- the trim check slitter position measurement system

Slitter repositioning can be fully automated or controlled manually. The slitters can be automatically repositioned while a full sheet is present in the slitter section. However, manual repositioning may only be done before threading.

WindPosit control logic provides precise slitter positioning based on feedback from various sensing devices on the transfer rod and trim check assemblies.

During normal operation, each of the band and blade carriages are locked to their respective slitter beams (band carriages to the upper beam, blade carriages to the lower beam). The pneumatic bellows on each carriage is inflated, causing a spring to expand and lock the carriage to its respective slitter beam. Although the band and blade carriages are aligned, they are not connected to each other.

When new roll widths are required, the operator sets up the desired roll widths on the control screens (**Figure 26, upper**), tests that the trim widths are achievable (**Figure 26, lower**), and then activates the transfer rods to reposition the slitters. All slitters being repositioned will react simultaneously. The affected band and blade carriages unlock from their respective slitter beams and lock to the transfer rods. The transfer rods are moved in the cross-machine direction, propelling the slitter carriages along ways bolted to each of the slitter beams. Once a slitter is in the desired position, the process reverses, locking the band and blade back onto their respective beams.

A trim check measurement scan will automatically take place at the completion of an automatic repositioning sequence. If the cutting edge of one or more slitters is outside an acceptable range compared to the operator entered roll widths, they will be automatically repositioned and another scan performed.

Summary

Valmet continually develops the winding process by improving equipment and controls. Winder improvements always bear safety in mind, and will typically improve capacity or quality as well. The simplest to the most complex winder improvements are all found on the latest OptiWin Family of winders from Valmet. But most of these improvements can be made to existing winders on a prioritized case-by-case basis. Valmet's winders are widely considered to be the safest in the world – and increased safety can be achieved by the proper selection of Valmet winder improvements for your winders.

This white paper combines technical information obtained from Valmet personnel and published Valmet articles and papers.

Valmet provides competitive technologies and services to the pulp, energy and paper industries. Valmet's pulp, paper and power professionals specialize in processes, machinery, equipment, services, paper machine clothing and filter fabrics. Our offering and experience cover the entire process life cycle including new production lines, rebuilds and services.

We are committed to moving our customers' performance forward.